

**OWNERS MANUAL  
“2000” PROSTAR  
190, 195, 205, 205V-  
DRIVE, X-STAR,  
X5, HANG TEN,  
SPORTSTAR 19  
SAMMY DUVALL  
SIGNATURE  
SERIES**

# **MasterCraft**

## *2000 Owners Manual*

**ProStar 190**

**ProStar 195**

**ProStar 205**

**ProStar 205 V-Drive**

**Sammy Duvall**  
**Signature Series**

**X-Star**

**X-5**

**Hang Ten**

**SportStar 19**

## Important Safety and Warranty Information

The manufacturer is not responsible for any personal injury or property damage that may occur if the operator does not read and understand the information in this manual. The manufacturer is not responsible for any personal injury or property damage that may occur if the operator does not read and understand the information in this manual. The manufacturer is not responsible for any personal injury or property damage that may occur if the operator does not read and understand the information in this manual.

CONSUMERS SHOULD NEVER ATTEMPT TO UNDERTAKE THE MAINTENANCE AND REPAIR PROCEDURES DESCRIBED IN THIS MANUAL.

## Welcome Aboard!

**C**ONGRATULATIONS ON YOUR CHOICE OF THE FINEST SKI BOAT AVAILABLE. MasterCraft is the recognized world leader for inboard ski boats today and has been for more than 30 consecutive years. The quality, innovation, selection and value are unmatched in the industry.

**P**LEASE TAKE A FEW MINUTES TO READ THIS OWNERS AND OPERATORS MANUAL COMPLETELY before you use your MasterCraft boat for the first time. It will help you answer most of the remaining questions you may have about your new boat.

**E**VERY EFFORT HAS BEEN MADE TO MAKE THIS MANUAL ACCURATE. ALL INFORMATION is based on the latest product information available at the time of printing.

**B**ECAUSE OF OUR POLICY OF CONTINUOUS PRODUCT IMPROVEMENT, WE RESERVE THE right to make changes at any time, without notice, in specifications and models and also to discontinue models. The right is also reserved to change specifications, parts or accessories at any time without incurring any obligation to equip the same on models manufactured before the date of the change.

**T**HE CONTINUING ACCURACY OF THIS MANUAL CANNOT BE GUARANTEED. THE illustrations used in this manual are intended only as representative reference views and may not depict actual model component parts. Information about certain on-board components furnished by suppliers other than MasterCraft is provided separately. This information is available from your dealer.

**NOTE:** The information given in this Owner's Manual may not be applicable to your boat's equipment. If you have any questions, please contact your local authority.

# Table of Contents

WELCOME ABOARD.....	1	Frequency and Scheduled	
CONSTRUCTION AND STANDARDS.....	3	Maintenance Tasks .....	44
Standard Features .....	3	Check Engine Oil Level .....	46
Certification .....	4	Check Transmission Fluid Level .....	46
Serial Number Locations .....	4	Check Cooling System Coolant	
SAFETY.....	6	Level .....	46
General Precautions .....	7	Check Engine Belts for Looseness	
Safety Equipment .....	7	or Damage .....	47
Safety Afloat .....	9	Check/Service Fuel Filter .....	47
RULES OF THE OPEN WATER.....	11	Inspect Engine Hardware .....	48
Steering and Sailing Rules and		Inspect Throttle/Shift Cables .....	48
Sound Signals .....	11	Inspect Battery .....	49
Rules When Encountering Vessels .....	12	Inspect Exhaust System .....	50
Other Special Situations .....	13	Inspect Propeller Shaft Log .....	50
GENERAL LAY-OUT.....	16	Inspect Fuel System .....	51
CONTROLS AND INDICATORS.....	18	Change Engine Oil .....	51
FUELING.....	24	Lubricate Engine Starter .....	52
SAFETY CHECKS AND SERVICES.....	26	Clean Engine Flame Arrestor .....	53
Before Each Operation .....	26	Engine Tune-Up .....	53
During Operation .....	26	Change Transmission Fluid .....	53
After Operation .....	26	Check Shaft Coupling Alignment .....	54
NEW BOAT BREAK-IN.....	27	Lubricate Steering System .....	54
STARTING AND BASIC OPERATION.....	30	Lubricate Shift/Throttle Cables .....	55
Before Starting .....	30	Inspect Exhaust Flaps .....	56
Starting the Engine .....	31	Check Engine Mounts .....	56
Shifting Gears .....	32	Inspect Complete Fuel System .....	56
Underway .....	32	UNSCHEDULED MAINTENANCE.....	58
Stopping .....	33	Changing Propellers .....	58
OPERATIONAL HINTS.....	34	Check/Repairing Propellers .....	59
General .....	34	Speedometer Calibration .....	60
First Time Operation .....	35	Replacing Lights .....	61
Basic Maneuvering .....	35	Replacing Fuses .....	61
High Speed Operation .....	36	STORAGE/WINTERIZATION.....	62
Unusual Operating Conditions .....	37	TROUBLESHOOTING.....	66
LIFTING THE BOAT.....	38	SPECIFICATIONS.....	70
CORROSION.....	40	OPTIONAL EQUIPMENT.....	72
CLEANING.....	41	DEALER SERVICE AND WARRANTY.....	74
SCHEDULED MAINTENANCE.....	44	LIMITED WARRANTY STATEMENT.....	77
Checks and Services .....	44	TRAILERING/LAUNCHING.....	79

# Construction and Standards

**A**LL MasterCraft BOATS ARE CONSTRUCTED OF THE HIGHEST QUALITY FIBERGLASS materials and resins available. We take pride in producing boats with the highest standards of quality and workmanship. Our commitment to excellence is evident in every part of the production process and facility. This commitment continues to the owner with our limited warranty.

The hull, deck, stringers and inner liner are 100 percent hand-laid, with up to 22 layers of fiberglass. All major hardware is anchored in steel or composites that have been in-laid into the hull and liner during the construction process.

All fasteners, hardware, handrails, shafting and lifting rings are made from premium-grade stainless steel. All parts operating in the water are constructed of bronze alloys. Every boat is lake-tested and quality-checked at the factory. A permanent quality record is kept for future reference.

**A**LL MasterCraft BOATS COME EQUIPPED WITH MANY STANDARD FEATURES. Among the skiing features are:

- anodized aluminum ski pylon
- oversized convex mirror
- tournament speedometers
- transom ski tow eye
- tracking fins.

Amenities include:

- driver's seat with rotocast frame
- teak swim platform
- drink holders
- color-coordinated upholstery
- acoustically insulated engine box
- hinged sun pad.

Among the safety-oriented features are:

- engine warning light
- tethered engine-stop switch
- rear-facing observer seats
- bilge blower & pump system
- vital warning and caution labels
- horn
- fire extinguisher
- navigational lighting.

Performance features encompass:

- instrumentation and custom gauges
- competition throttle control
- SilentMaster muffler/exhaust system
- a General Motors state-of-the-art, fuel-injected V-8 engine.

## Standard Features

## Certification

AS AN ACTIVE MEMBER OF THE NATIONAL MARINE MANUFACTURERS ASSOCIATION (NMMA), every MasterCraft boat and trailer meets or exceeds the rigid specifications for certification. This affirmation exceeds the federally mandated United States Coast Guard (USCG) requirements and is backed by the 600-member NMMA.

Inspections are performed annually by a nationally recognized, independent testing organization—the NMMA. Inspectors visit the plant each year before the model year begins to check all our models for conformance. The inspectors then return—unannounced—during the year to insure continued compliance with certification requirements.

Certification checks are developed by the NMMA engineering staff and the Marine Service Practices Committee to help guard against over-powering, over-loading, fire, explosion, sinking and collisions.

All parts used in the construction of MasterCraft boats meet or exceed USCG and American Boat and Yacht Council (ABYC) standards.



**IMPORTANT:** It is the boat owner's responsibility to see that *all* maintenance described in this book is performed as required. Failure to do will result in voiding the warranty! Routine maintenance is not covered under warranty and charges will be paid by the boat owner. Services should be provided by a MasterCraft-approved dealer, but if work is completed by the boat owner, he must retain all receipts for parts used. These parts must be of marine grade. Maintenance performed by anyone other than a MasterCraft-approved dealer may result in voiding of the warranty!

## Hull

### Serial Number Locations

THE HULL IDENTIFICATION NUMBER (HIN) CAN BE FOUND AT THE TOP, OUTSIDE, starboard corner of the transom. The HIN is molded into the transom and federal law prohibits removal or tampering in any way.

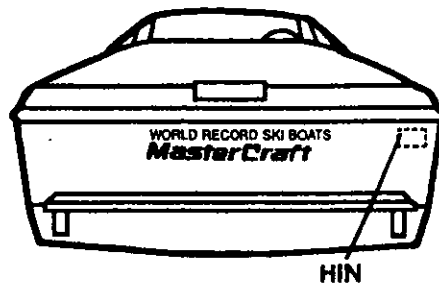

mon sense when operating your boat. Don't take unnecessary chances!

Be certain that all boat operators are aware of this information and conform to boat safety principles.

**B**OATING SAFETY STARTS WITH A THOROUGH UNDERSTANDING OF OPERATION. IN addition to careful review of this manual, you should be aware as well that there are many sources of information available. MasterCraft urges you to pursue additional training.

The following is a listing of just some of the agencies and organizations that offer safety training or information:

- American Red Cross, National HQ  
8111 Gatehouse Road, 6th Floor  
Falls Church VA 22042  
(202) 737-8300
- American Water Ski Association (AWSA)  
799 Overlook Drive  
Winter Haven FL 33884  
(941) 324-4341
- Boat Owners Association of the United States (BOAT/US)  
880 South Pickett Street  
Alexandria VA 22304  
(703) 823-9550
- National Safe Boating Council  
2550 M Street NW, Suite 425  
Washington DC 20037  
(202) 296-4588
- U.S. Coast Guard Auxiliary Commandant (G-NAB)  
2100 Second Street SW  
Washington DC 20593-0001  
(202) 267-1001

**F**EDERAL LAW REQUIRES CERTAIN SAFETY EQUIPMENT TO BE ON-BOARD AT ALL times. In addition, responsible boaters carry other equipment in case of emergency. Check with the local boating authorities for any additional requirements over and above the federal stipulations.

## **General Precautions**

## **Safety Equipment**

# Safety

**Y**OUR SAFETY, AS WELL AS THE SAFETY OF OTHERS WITH AND AROUND YOU, IS A direct result of how you operate and maintain your boat. Read and comprehend this manual. Make sure that you understand all the controls and operating instructions before attempting to operate the boat. *Improper operation is extremely dangerous.*

The basic safety rules are outlined in this section of the manual. Additional precautions throughout the manual are noted by the following symbols.



This indicates a potentially hazardous situation, which, if not avoided, could result in *death or serious injury*.



This symbol indicates a potentially hazardous circumstance, which, if not avoided, may result in *minor or moderate injury*. It may also be used to alert against unsafe practices.



This sign indicates an imminently hazardous situation, which, if not avoided, will result in *death or serious injury*. This is limited to the most extreme situations.

**The precautions listed in this manual and on the boat are not all-inclusive. If a procedure, method, tool or part is not specifically recommended by MasterCraft, you must satisfy yourself that it is safe for you and others, and that the boat will not be damaged or made unsafe as a result of your decision. REMEMBER: ALWAYS USE COMMON SENSE WHEN OPERATING, SERVICING OR REPAIRING THE BOAT!**

In addition to everyday safety, failure to observe the safety recommendations may result in severe personal injury or death to you or to others. Use caution and com-



## Required Equipment

**Y**OUR MasterCraft HAS BEEN EQUIPPED AT THE FACTORY WITH MOST OF THE federally required safety equipment for inland waters (Class 1, 16'-to-26'). This equipment includes:

- UL-approved Marine Fire Extinguisher, Type A-BC (2 lbs.), good for solids, liquids, and electrical fires
- ABYC-approved Marine Mufflers with water injection
- USCG-approved Marine Flame Arrestor
- USCG-approved Engine Box Ventilation with spark-less power blower
- ABYC-approved Electric Horn sound warning device
- USCG-approved inland lighting

Federal law also requires at least one Type I, II or III Personal Flotation Device (PFD) for each person on board or being towed on water skis or other recreational equipment. In addition, one throwable Type IV PFD must also be on board. As the owner, obtaining the appropriate PFDs is your responsibility. Your MasterCraft dealer can—and will be happy to—assist you.



## Recommended Equipment

**A** SMART OWNER WILL AVOID POTENTIAL PROBLEMS ON AN OUTING BY HAVING additional equipment on board. Normally, this equipment is dependent on the body of water and the length of the trip.

We suggest the following—as a minimum. Your MasterCraft dealer can also assist you with additional recommendations.

- An anchor with at least 75-feet of line
- A manual bailing device for removing water
- A combination oar/boat hook
- A day-and-night visual distress signal
- A first aid kit and manual
- An airway breathing tube
- A waterproof flashlight
- A set of local navigation charts
- Mooring lines and fenders
- Extra engine oil
- A tool kit
- A portable, battery-operated AM/FM radio

**B**OATING-RELATED ACCIDENTS ARE GENERALLY CAUSED BY THE OPERATOR'S failure to follow basic safety rules or written precautions. Most accidents can be avoided if the operator is completely familiar with the boat, its operation, and can recognize potentially hazardous situations before an accident occurs.

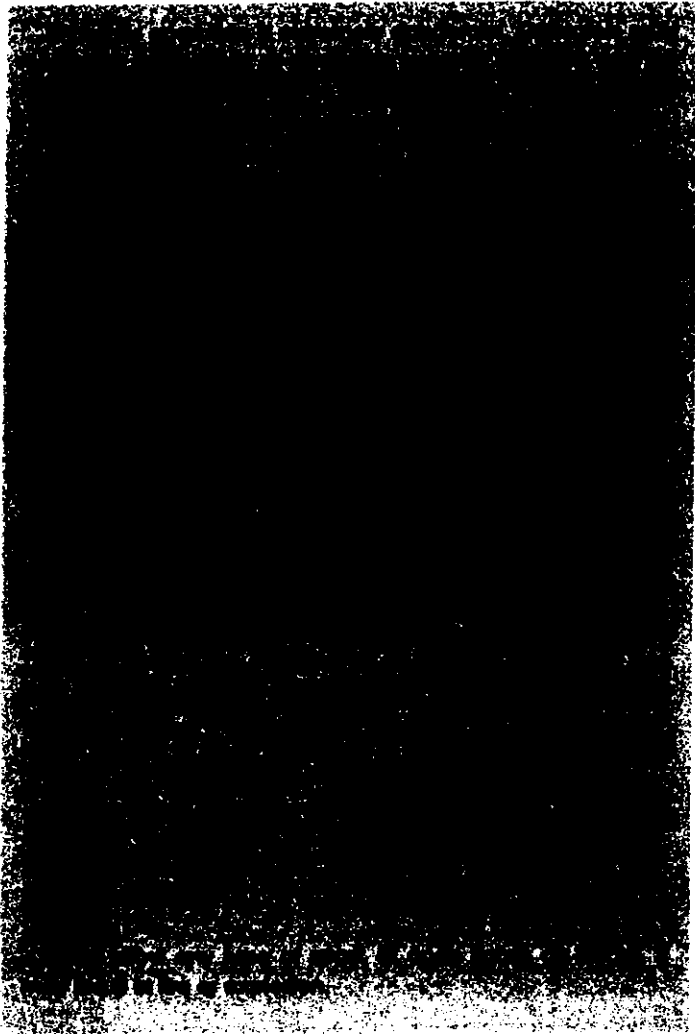

## *Safety Afloat*



### **WARNING**

Failure to adhere to these warnings may result in severe injury or death to you and/or others.

**S**KIERS ARE OBLIGATED TO BE AS AWARE OF THE FUNDAMENTAL SAFETY RULES AS operators must. If you are new to water skiing, seek certified training before starting. You will find it especially helpful to join a local ski club and the AWSA, when possible.

Always remember that the majority of water skiing injuries are the result of impacts with other objects, so always look where you are going and be aware of what is going on around you.

## *Skiing Safety*

# Rules of the Open Water

**J**UST AS THERE ARE RULES WHICH APPLY WHEN DRIVING A VEHICLE ON THE STREET, there are waterway rules which apply when you are driving a boat. These rules are used internationally, and they are also enforced by the United States Coast Guard and local agencies. You should be aware of these rules and follow them whenever you encounter another vessel on the water.

In various geographic locations certain rules prevail that may be unique to the locale, but all are basically the same as the International Rules of the Road.

The rules presented in this manual are condensed and have been provided as a convenience only. Consult your local U.S. Coast Guard Auxiliary (USCGA), Department of Motor Vehicles (DMV) or Department of Natural Resources (DNR) for a complete set of rules governing the waters in which you will be using your boat. If you plan to travel—even for a short trip—you would be well served to contact the regional USCGA, DMV or DNR in the area where you will be boating.

**A**NY TIME TWO VESSELS ON THE WATER MEET ONE ANOTHER, ONE VESSEL HAS the right-of-way. It is called the *stand-on* vessel. The vessel which does NOT have the right-of-way is called the *give-way* or *burdened* vessel.

These rules determine which vessel has the right-of-way, and accordingly, what each vessel should do.

**T**HE VESSEL WITH THE RIGHT-OF-WAY HAS THE DUTY TO CONTINUE ITS COURSE and speed, except to avoid an immediate collision. When you maintain your direction and speed, the other vessel will be able to determine how best to avoid you.

**T**HE VESSEL WHICH DOES NOT HAVE THE RIGHT-OF-WAY HAS THE DUTY TO TAKE positive and timely action to stay out of the way of the *stand-on* vessel. Normally, the *give-way* vessel should not cross in front of the *stand-on* vessel. Slow down or change directions briefly and pass behind the other vessel. You should always move in such a way that the *stand-on* operator can see what you are doing.

## **Steering and Sailing Rules/Sound Signals**

### **Stand-On Vessel**

### **Give-Way Vessel**



### CAUTION

Failure to adhere to this caution may result in injury.



### WARNING

Failure to adhere to these warnings may result in severe injury or death to you and/or others.

**T**HE USE OF AN UNAPPROVED SKI PYLON EXTENSION OR EXTENSIONS IS NOT RECOMMENDED BY MasterCraft on our products. If you elect to use unapproved merchandise, be aware that they could create excessive stress on your boat and could result in damage not covered by the warranty. MasterCraft offers a pylon extension tower that has been factory-tested and will not damage your boat when used as directed. Use of any other pylon tower may void your warranty.

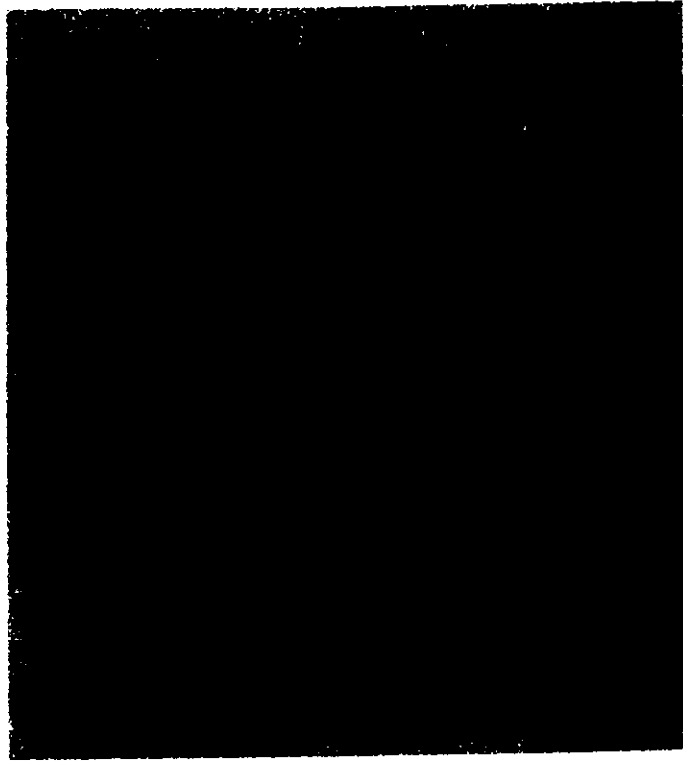

### Warning Plates and Labels

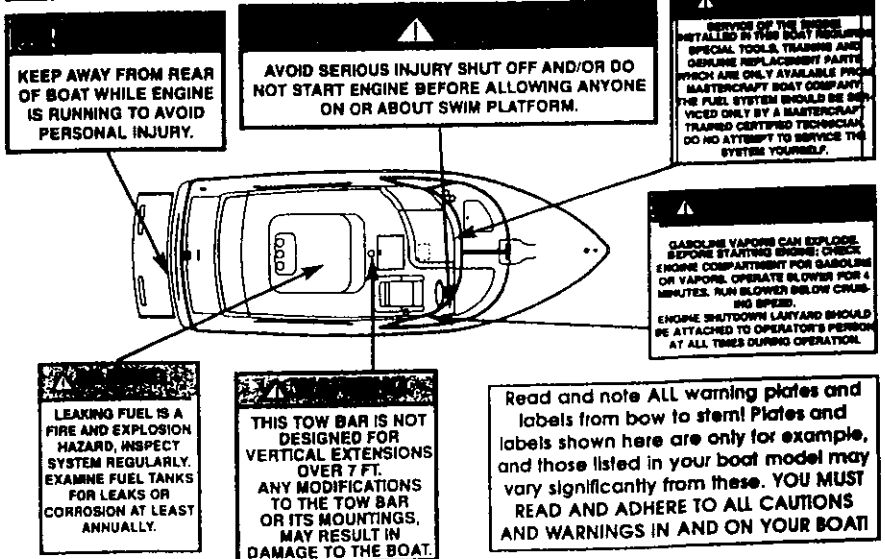

## The General Prudential Rule

## Rules When Encountering Vessels

THIS RULE IS CALLED *RULE 2* IN THE INTERNATIONAL RULES AND SAYS,



THERE ARE THREE MAIN SITUATIONS IN WHICH YOU MAY ENCOUNTER OTHER vessels and you must observe the Steering Rules in order to avoid a collision. These are:

- **Meeting** (you are approaching another vessel head-on)
- **Crossing** (you are traveling across the other vessel's path)
- **Overtaking** (you are passing or being passed by another vessel)

Using the following illustration in which you are the boat in the center, you should give right-of-way to all vessels shown in the white area. In this instance, you are the give-way vessel. All vessels in the shaded area must yield to you as you are the stand-on vessel. Both you and the meeting vessel must alter course to avoid each other.

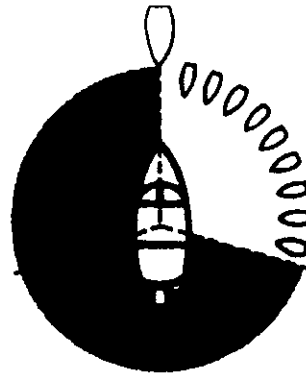

### Meeting

IF YOU ARE MEETING ANOTHER POWER VESSEL HEAD-ON, AND YOU ARE CLOSE enough to run the risk of collision, neither of you has the right-of-way. Both of you should alter course to avoid an accident. You should keep the other vessel on your port (left) side. This rule doesn't apply if both of you can clear each other by continuing your set course and speed.

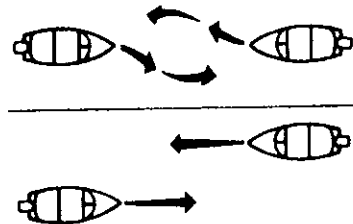

### Fishing Vessel Right-of-Way

If you navigate these type of waters, you should carry a portable air horn, which are available from local marine supply stores.

**A**LL VESSELS WHICH ARE FISHING WITH NETS, LINES OR TRAWLS ARE CONSIDERED under International Rules to be *fishing vessels*. Boats with trolling lines are not considered fishing vessels.

Fishing vessels have the right-of-way, regardless of position. These vessels, however, cannot impede the passage of other vessels in narrow channels.

### Sailing Vessel Right-of-Way

**S**AILING VESSELS SHOULD NORMALLY BE GIVEN THE RIGHT-OF-WAY. THE exceptions to this are:

...When the sailing vessel is overtaking the power-driven vessel, the power-driven vessel has the right-of-way.

...Sailing vessels should keep clear of any fishing vessel.

...In a narrow channel, a sailing vessel should not hamper the safe passage of a power-driven vessel which can navigate only in such a channel.

### Reading Buoys and Other Markers

**T**HE WATERS OF THE UNITED STATES ARE MARKED FOR SAFE NAVIGATION BY THE lateral system of buoyage. The markers and buoys you will encounter have an arrangement of shapes, colors, numbers and lights to show which side of the buoy a boater should pass when navigating in a particular direction.

The markings on these buoys are oriented from the perspective of being entered from seaward while the boater is going towards the port. This means that red buoys are passed on the starboard (right) side when proceeding from open water into port, and black buoys are to port (left) side. When navigating out of port, your position to the buoys should be reversed: red buoys to port and black buoys to starboard.

Many boating bodies of water are entirely within the boundaries of a single state. The Uniform State Waterway Marking Systems has been devised for these waters. This system uses buoys and signs with distinctive shapes and colors to show regulatory or advisory information.

These markers are white with black letters and orange borders. The information signifies speed zones, restricted areas, danger areas and general information.

Remember: Markings may vary by geographic location. Always consult local boating authorities before driving your boat in unfamiliar waters.

**W**HEN TWO POWER-DRIVEN VESSELS ARE CROSSING EACH OTHER'S PATH CLOSE enough to run the risk of collision, the vessel that views the crossing vessel to the starboard (right) side must give-way.

If the other vessel is to the port (left) side, maintain your course and direction, provided the other vessel gives you the right-of-way as it should.

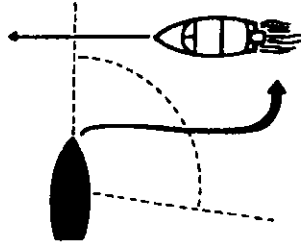

**I**F YOU ARE PASSING ANOTHER VESSEL, YOU ARE THE GIVE-WAY VESSEL. THIS MEANS that the other vessel is expected to maintain its course and speed. You must stay out of its way as you clear it, altering course and speed as necessary.

Conversely, if you are being passed by another vessel, you should maintain your speed and direction so that the other vessel can steer itself around you.

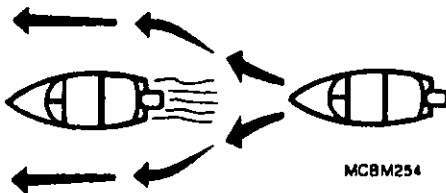

**T**HERE ARE THREE OTHER RULES TO ALWAYS REMEMBER WHEN DRIVING YOUR boat around other vessels:

**W**HEN NAVIGATING IN NARROW CHANNELS, YOU SHOULD KEEP TO THE RIGHT when it is safe and practical to do so. If the operator of a power-driven vessel is preparing to go around a bend that may obstruct the view of other water vessels, the operator should sound a prolonged blast on the whistle or horn—four to six seconds.

If another vessel is around the bend, it too should sound the whistle or horn. Even if no reply is heard, however, the vessel should still proceed around the bend with caution.

## Crossing

## Overtaking

## Other Special Situations

## Narrow Channels and Bends

## Examples of Buoys and Markers

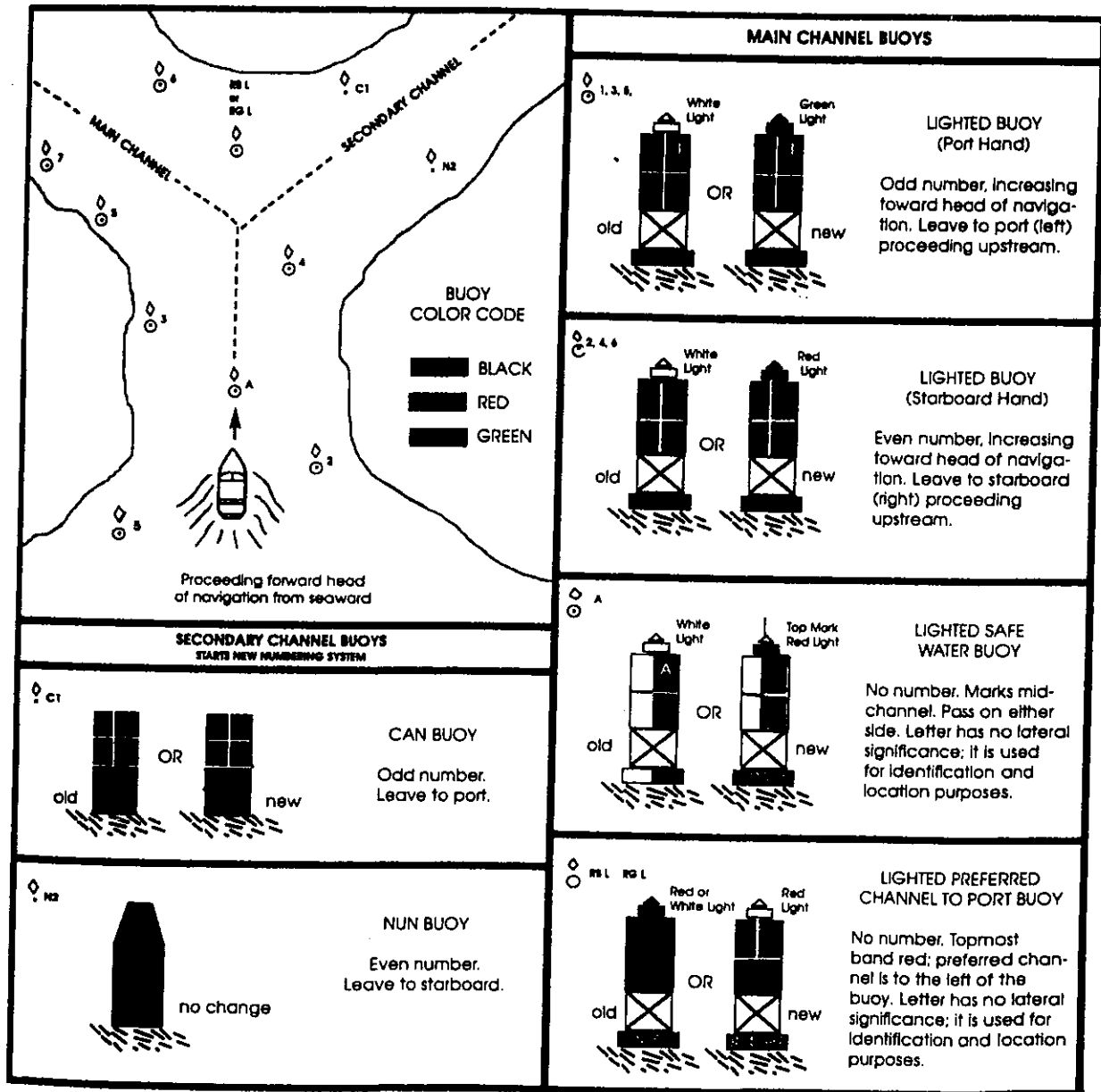



# General Layout

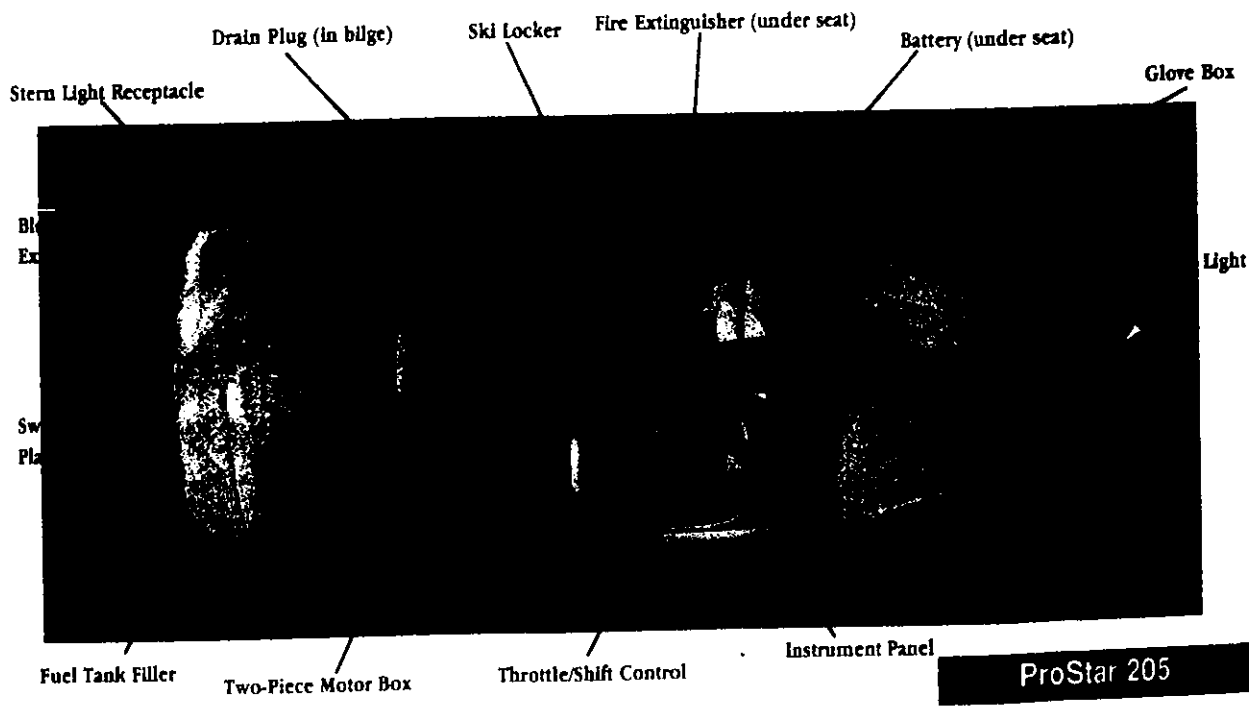
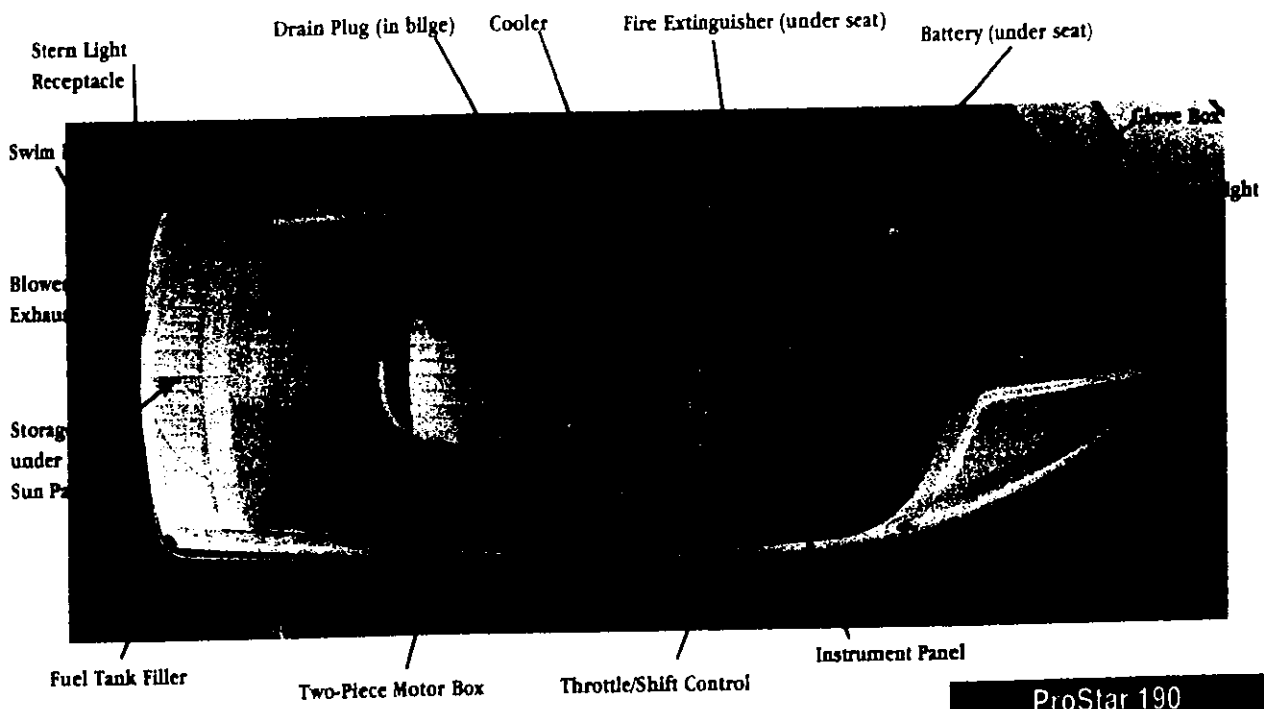

The layouts pictured on these two pages are general in nature for the ProStar and SportStar models. You should carefully review your boat from bow to stern to determine the actual locations of items.

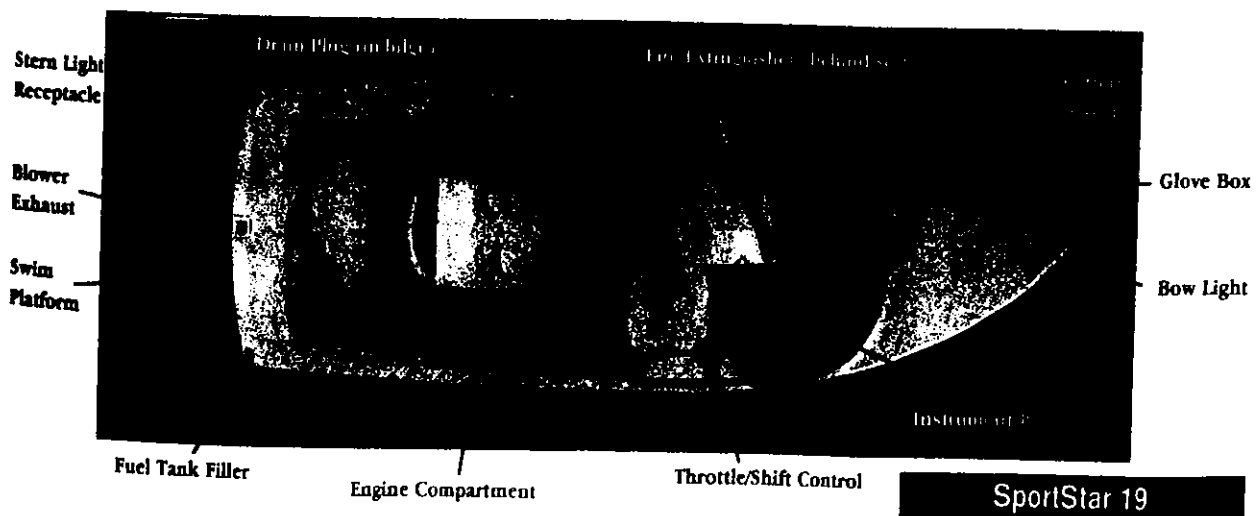
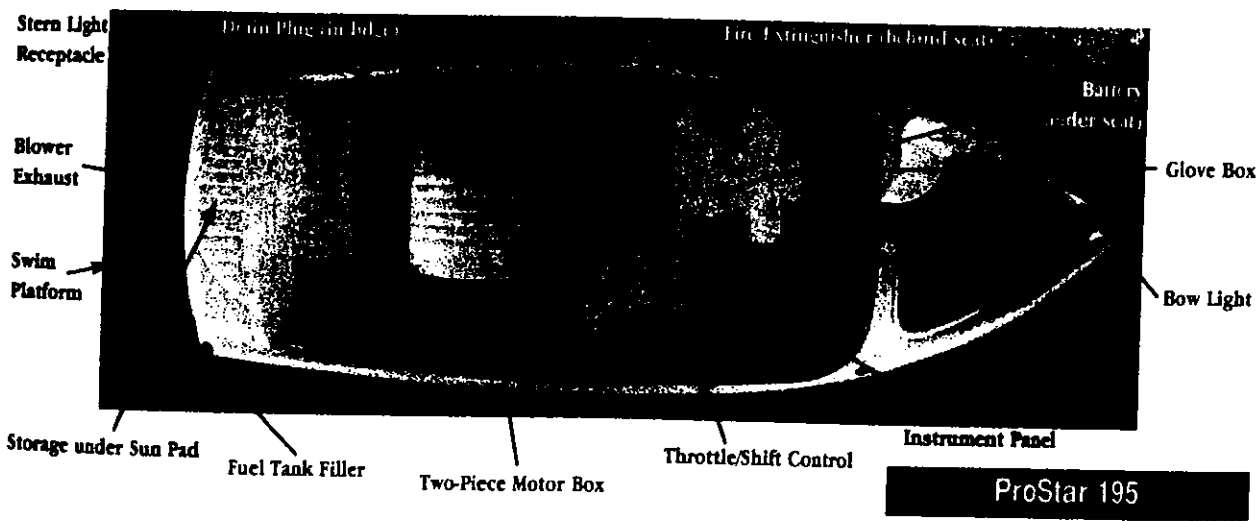
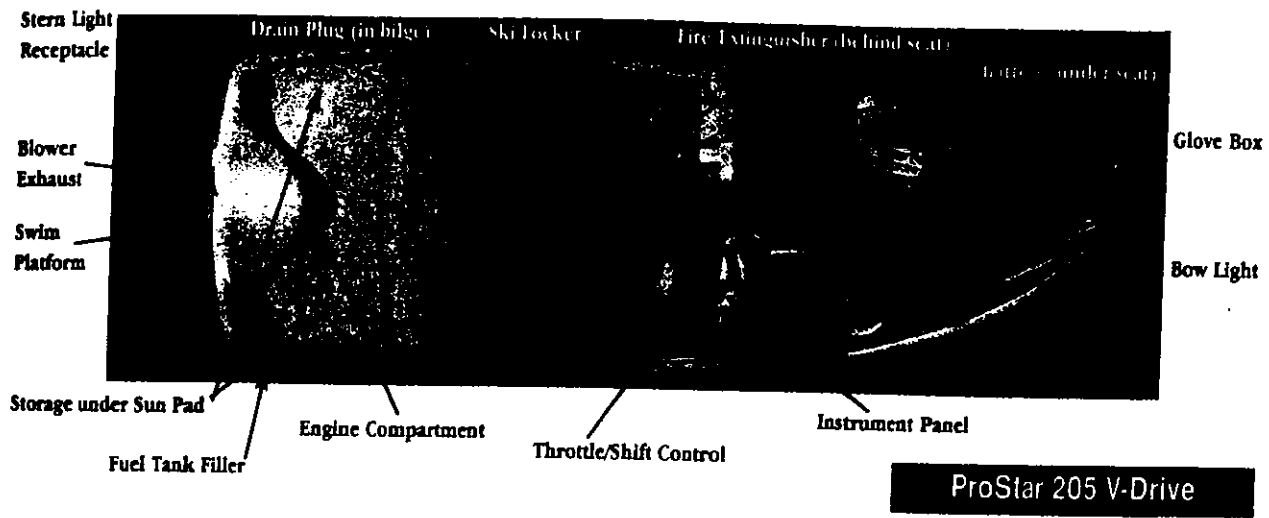

# Controls and Indicators

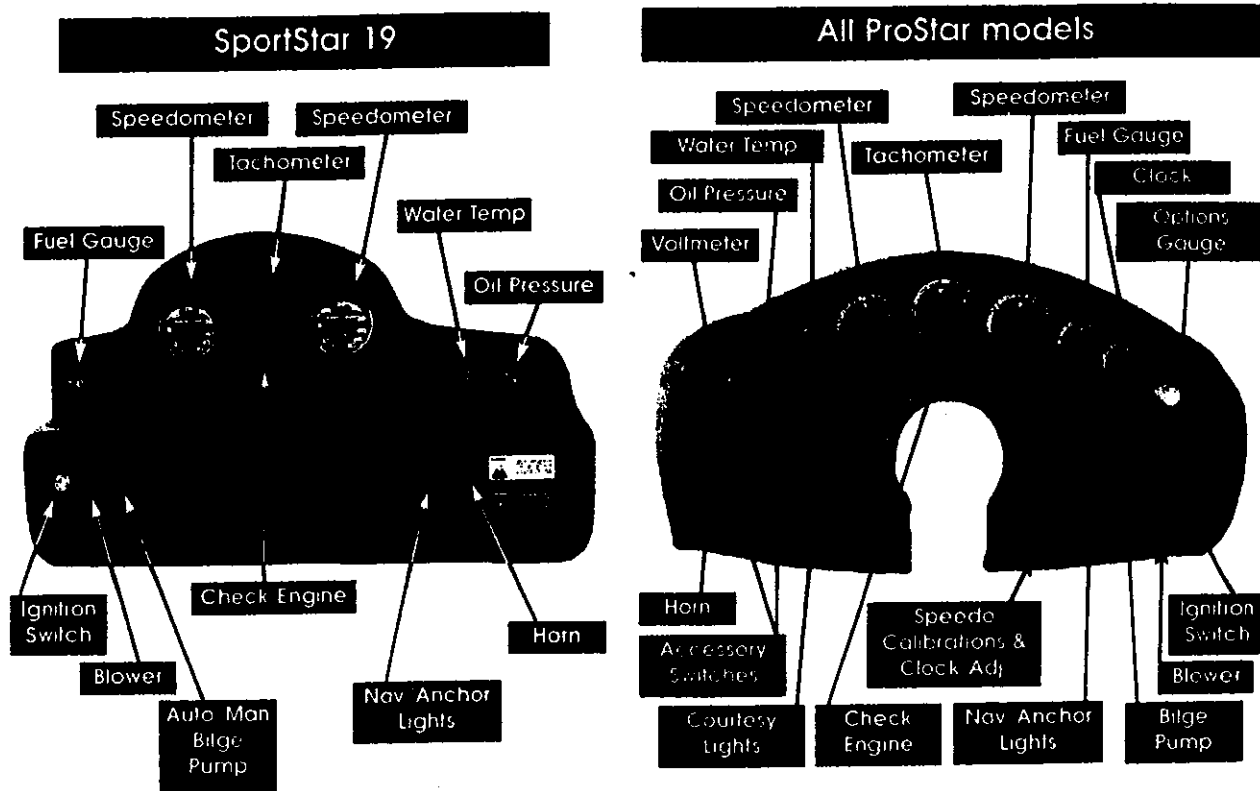

## 1 Speedometer

**T**HE SPEEDOMETER INDICATES FORWARD SPEED OF BOAT IN MILES PER HOUR. Dual speedometers are required for tournament use in case of a failure during a run. The speedometer calibration switches are located on the lower right panel, next to the navigation/anchor light switch. More information on calibration appears elsewhere.

## 2 Tachometer/ Engine Hourmeter

**T**HE TACHOMETER INDICATES THE ENGINE SPEED IN CRANKSHAFT REVOLUTIONS per minute (RPM). Propeller shaft RPM is the same as the engine except for boats equipped with the Power Slot 1.5-to-1 ratio package, in which case propeller shaft RPM is less than that of the engine RPM.

The engine hourmeter registers accumulated engine operating time and is activated when the engine is turning at least 300 RPM (above idle). Use the hourmeter to keep accurate logs for scheduled maintenance.

**T**HIS GAUGE INDICATES THE ELECTRICAL SYSTEM OPERATING CURRENT IN DC volts. Normal operating voltage is between 12.8 and 14.8 volts with the engine running.

Voltmeter ..... 

**T**HE FUEL GAUGE INDICATES THE APPROXIMATE AMOUNT OF FUEL IN THE FUEL tank as measured in quarters of a tank. Readings are only approximate and should be compared to the hours of operation multiplied by the known fuel consumption (gallons-per-hour or GPH).

Fuel Gauge ..... 

The gauge is activated with the ignition switch. Rocking motion of the boat during normal operation will cause fluctuation of the fuel gauge. For a more accurate reading, make sure that the boat is level and at rest.

Although it may be possible to see fuel in the bottom of the fuel tank, you may not be able to operate the boat. The fuel pick-up system was designed to avoid introducing the water and debris that inevitably accumulates in the bottom of the tank. Rather than relying on visual inspection, you should watch the fuel gauge and your GPH.

**T**HE ENGINE TEMPERATURE GAUGE INDICATES THE COOLING WATER TEMPERATURE inside the engine as measured in degrees Fahrenheit.

Engine .....   
Temperature Gauge

The normal operating temperature will range from 140° to 190° degrees. Engines with electronic fuel injection also have a control circuit inside the engine control module that will cause the engine to run at reduced speeds if the module senses that the the engine is running too hot. If you notice that your speed has reduced during normal operation without reducing the throttle, monitor your temperature gauge. If the gauge indicates excessive temperatures during operation, slow down immediately and turn off the ignition.



**NOTE: Damage to your engine from neglected action while running too hot can be costly. It is not covered by your warranty!**

## Engine Oil Pressure Gauge

**T**HE ENGINE OIL PRESSURE GAUGE INDICATES THE PRESSURE OF THE LUBRICATING oil inside the engine. The average pressure ranges are between 6 pounds-per-square-inch (PSI) at 1000 RPM and 40 PSI at cruise range speeds. A reading of pressures below 5 PSI at 1000 RPM may be caused by a low oil level or other potentially serious problems that result in low oil pressure. If you experience low oil pressure, stop your engine immediately and check your oil level before operating again.



**NOTE: Damage to your engine from neglected oil problems can be costly. Such damage is not covered by your warranty!**

## Check Engine Light

**T**HE RED MALFUNCTION INDICATOR CHECK ENGINE LIGHT IS LOCATED AT THE upper section of the dash panel. This gauge operates from an on-board computer that monitors the operation of your fuel, ignition and engine control systems.

The Check Engine light should come on when the key is in the ON position and the engine is not running. This is a check to show you that it is working. If it does not come on at all, have it repaired by your MasterCraft dealer right away.

If it stays on—or comes on while you are operating your boat—the computer is indicating that you have a problem. You should take your boat to your MasterCraft dealer for immediate service.

The Check Engine light is supplemented with a warning buzzer that sounds when the the key is in the ON position and the engine is not running, or when one of a number of issues arises with the engine that may require mechanical service.

**NOTICE: If you continue to operate your boat with this light on, you could adversely affect the emission control systems on the engine. You could also experience poor fuel economy, and your engine may not run as smoothly. This could lead to costly repairs not covered by your warranty.**

THE ENGINE IDENTIFICATION NUMBER (EIN) IS IMPRINTED ON THE STARBOARD (right) side of the oil pan.

THE TRANSMISSION IDENTIFICATION NUMBER (TIN) IS IMPRINTED ON A PLATE FOUND on the top, port (left) side of the housing.

MASTERCRAFT TRAILERS HAVE A STICKER ON THE LEFT-HAND SIDE OF THE FRAME that lists the trailer's identification number.

**T**HE IDENTIFICATION NUMBERS OF YOUR BOAT ARE IMPORTANT TO YOU. RECORD the serial and model numbers of your boat in the spaces provided. *Keep a copy of these numbers on a separate sheet of paper and store in a safe place other than your boat.*

In case of theft, report these numbers in writing to local authorities, your insurance agent and MasterCraft in care of: Customer Service, MasterCraft Boat Company, 100 Cherokee Cove Drive, Vonore TN 37885.

Engine

Transmission

Trailer

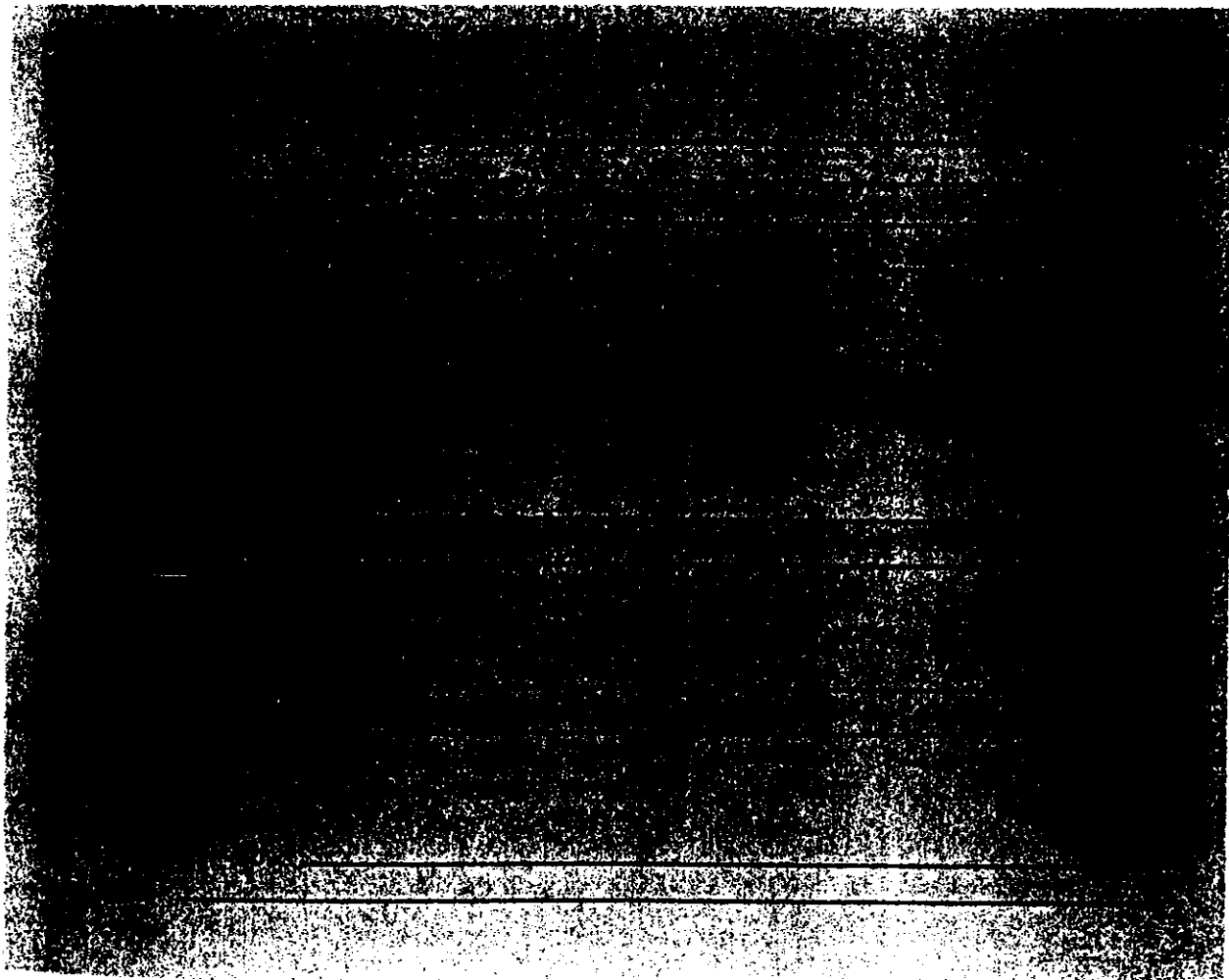

**T**HE STEERING WHEEL IS MECHANICALLY LINKED TO THE RUDDER BY A PUSH/PULL cable.

**A** ONE-HAND, SINGLE-LEVER CONTROL OPERATES AS BOTH A GEAR SHIFTER AND A throttle. The lever automatically locks in the neutral position (straight up and down) for safety. The lever can only be moved from neutral by raising the lifter "A" under the ball knob.

Shifting is accomplished by moving the lever into the first 45 degrees of travel. Push the lever for forward and pull it back for reverse. By advancing the lever beyond 45 degrees you move from the shifting range to the throttle range. Never attempt to shift without the engine running. The shift mechanism of this control can be temporarily disengaged with button "B". This allows the engine to increase RPMs in neutral during warm-up.

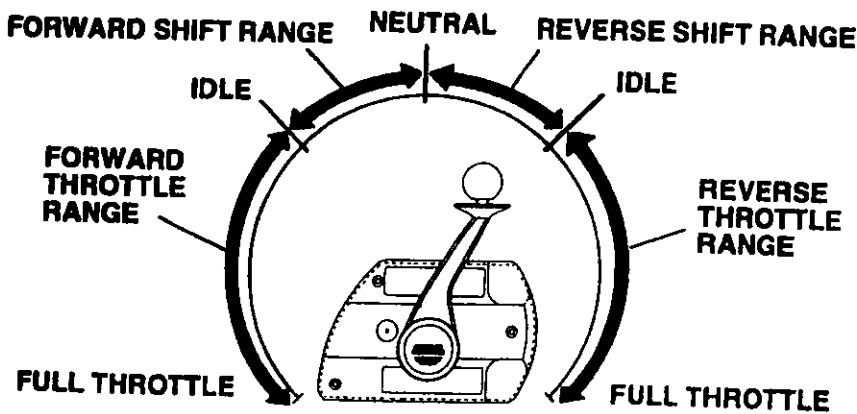

**Y**OUR BOAT IS EQUIPPED WITH A CLOCK, UNLESS YOU HAVE SELECTED AN OPTIONAL depth finder. The clock adjustment switch is located on the lower right hand side of the instrument panel, between the speedometer calibration switches.

**T**HE SPEEDOMETER CALIBRATION SWITCHES ARE LOCATED ON THE INSTRUMENT panel beside the navigational light switch. These switches are three-position rockers.

**I**NFORMATION REGARDING THE RADIO REMOTE CONTROL SWITCH IS INCLUDED IN your specially prepared new owner's packet and comes directly from the manufacturer. The radio remote option is mounted on the driver's side panel.

**C**OURTESY LIGHTS ADD ILLUMINATION FOR NIGHT-TIME BOATING ENJOYMENT. THE on-off switch is located on the lower left hand panel of the dashboard.

Steering Wheel .....

Shift/Throttle Control .....

**IMPORTANT:**  
Driver's should frequently review the gauges anytime the engine is turned on. Information provided by the gauges may be an early warning of potential problems. Some serious drive-train problems can be avoided by monitoring gauges.

Clock .....

Speedometer Calibration .....

Radio Remote Control .....

Courtesy Lights .....

**T**HE IGNITION SWITCH HAS FOUR POSITIONS:

- accessory (powers stereo)
- off
- run (ignition)
- start

Never leave the switch in the RUN position without the engine running; this will prevent the natural discharge of the battery. It is also used to activate the instrumentation components.

**T**HE EMERGENCY ENGINE SAFETY SWITCH CALLED THE LANYARD IS ILLUSTRATED on page 31. It is an ignition cut-off switch designed to stop the engine in the event of an operator being thrown from position or moving too far from the helm.

The lanyard is equipped with a hook on one end for attachment to your clothing, and the opposite end has a slide that fits over the switch. Be sure that the slide is firmly attached to the switch before starting. The switch is located on the throttle control box. *If the slide is left off or loose, the engine will crank but will not start.*



**T**HIS BUTTON ACTIVATES THE ELECTRIC HORN. PUSH AND HOLD TO SOUND THE horn.

**A** THREE-POSITION ROCKER SWITCH SERVES AS THE INSTRUMENTATION LIGHTING switch, the bow (red/green) and stern (white) lights for night running, and stern-only lights for use when anchored at night.

Push the top half of the switch (toward NAV) to turn all lights ON. Push the bottom half of the switch (toward ANC) to turn only the stern light ON. When the switch is at center, it is OFF.

**A** TWO-POSITION ROCKER SWITCH ACTIVATES THE ENGINE BOX VENTILATION blower. Push the top half of the switch to turn the blower ON.

**NOTE:** The blower must be operated for a minimum of four (4) minutes before starting the engine at any time. The blower must also be operated during idle and slow-speed running, but is not necessary at cruising speed.

Ignition Switch ..... 

Safety Switch ..... 

 **WARNING**

Horn Button .....  10

Instrument .....   
& Navigational Lights/  
Anchor Lights

Blower Switch .....  12



 **WARNING**

 ..... **Accessory Switch**

 ..... **Manual & Automatic Bilge Pump Switch**

 ..... **Circuit Breakers**

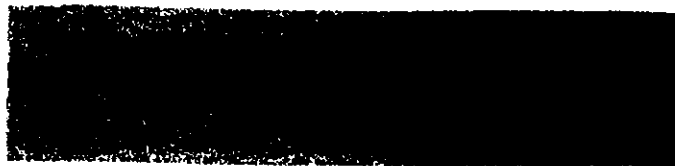

**A** ROCKER SWITCH ACTIVATES A CONNECTED ACCESSORY. IF THE BOAT IS EQUIPPED with the optional heater, the three-position switch operates the option. Push the top half of the switch to turn the accessory ON. The other switches are two-position, and these are available for a variety of optional connections.

**A** THREE-POSITION ROCKER SWITCH ACTIVATES THE BILGE PUMP. PUSH THE TOP half of the switch to turn the bilge pump to the manual ON position. Press the switch down to activate the bilge pump for automatic mode while the boat is underway. When the switch is centered, the bilge pump is off.

**A** LL MAJOR BOAT CIRCUITS ARE PROTECTED FROM SHORTING AND OVERLOAD BY resettable circuit breakers. If a problem develops with one of the following circuits, switch OFF the circuit and wait about one minute. Then push the appropriate breaker button fully and switch ON the circuit. If the circuit continues to trip, there is a problem somewhere that must be attended to immediately. See your MasterCraft dealer.



**U**nder the dash board is the breaker panel. Push appropriate button to re-set the breaker.



**I**n addition, there is a fuse at the battery box to assist with accessory loads. If the boat's accessories are not functional, also check this fuse.

possibility of gas or oil leakage detection. As part of your daily inspection, include a visual check of the orange fire sleeved fuel line. If you see damage to the sleeve or line—or in any way suspect damage or fuel leakage, **DO NOT start your boat!!** Immediately call your MasterCraft servicing dealer and let him assess the situation.

Units such as those listed above, are equipped with a pump-in-tank fuel module that has an internal check-valve system, and therefore does not require a shut-off valve. In the SportStar 19, however, the system does feature a valve. If at any time a fuel line leak is detected in your SportStar 19 boat, turn off the fuel valve (pictured to the right, which is located on the fuel tank, to stop the fuel supply flow and immediately consult your dealer for proper repair.



### Special Instructions for the SportStar 19

We do not recommend that you use alcohol-modified fuels in your MasterCraft boat because of the following side effects:

- **Moisture**—Alcohol-blended fuels absorb and keep moisture. Moisture inside the fuel tank can cause many engine problems. Fuel tank inspection and cleaning must be done more often.
- **Performance**—Alcohol-blended fuels cause the engine to operate on a leaner fuel/air ratio and may cause hard starting, stalling and vapor lock. Engine damage may result.
- **Deterioration**—Alcohol quickly deteriorates rubber and plastic components in the fuel system, causing more frequent inspection and replacement of parts. This increases the potential for fire and explosion due to fuel leakage. The new fuel system, however, is designed to withstand alcohol and MTBE fuel additives commonly found in the new "oxygenated" fuels. We still recommend fuels with as little alcohol as possible due to the moisture absorption problem identified above.

### Alternatives & Additives

**NOTE: Fuel additives and treatments, other than conditioners for moisture absorption and winter storage, are not recommended for use in MasterCraft Power engines.**

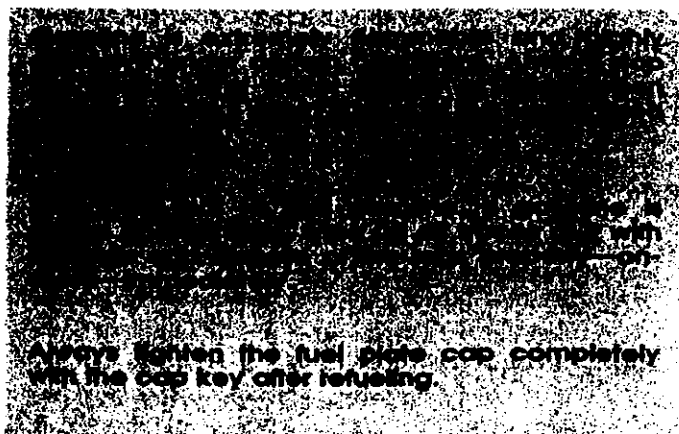

Always tighten the fuel plate cap completely with the cap key after refueling.



# Fueling

**T**HE IGNITION TIMING AS SET BY THE FACTORY REQUIRES THE USE OF LEADED OR unleaded fuel with an Anti-Knock Index Number (AKI)/Pump Octane Number range between 89 octane and 93 octane. Nearly any medium-grade gasoline available for automotive use may be used.



## Fuel System for All ProStar models



All ProStar models are equipped with a new, highly innovative fuel system. This system is designed to provide you with years of trouble-free service. Some of the latest innovations related to fuel handling safety are also incorporated into the fuel delivery system.

The system uses a fuel pump mounted in a capsule that is installed directly in the fuel tank. A similar system has been used in automotive vehicles for over a decade and has provided years of proven service. The pump system in your boat was specifically designed for the marine environment and contains a number of added safety components that are unique to the marine system. *Because of the special nature of the design, there are no user serviceable parts.* Any parts in need of service or maintenance will need to be addressed by your MasterCraft dealer. The technical team there is equipped with the **special tools** needed to disassemble and service the fuel capsule and associated parts.

The fuel line that travels in the boat's bilge area from the tank to the engine is a special multi-layer armored line that is covered with a special material known as a fire sleeve. The fire sleeve affords protection to the fuel line in the unlikely event of a boat fire.

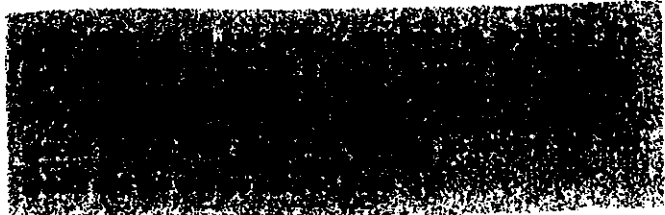

The sleeve is colored orange in order to afford easy identification of the fuel line. MasterCraft recommends daily inspection of the bilge for foreign materials and the

# Safety Checks and Services

**T**HE FOLLOWING CHECKS AND SERVICES ARE ESSENTIAL TO SAFE BOATING AND must be performed. Get in the habit of performing these checks in the same order each time so that it becomes routine.



## WARNING

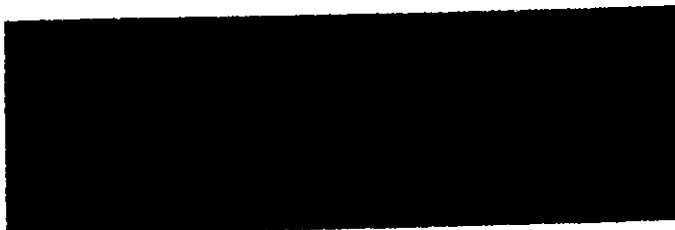

### *Before Each Operation*

- ✓ Check the weather report, wind and water conditions.\*
- ✓ Check for recommended on-board tools and parts.\*
- ✓ Check that the bilge drain plug is installed properly.\*
- ✓ Check the propeller and shaft for damage.\*
- ✓ Check the cooling water intake pick-up and transmission cooler for blockage.\* (See page 45 for more information.)
- ✓ Check the raw water impeller if the boat showed signs of overheating during the last usage.
- ✓ Check engine oil level.
- ✓ Check that there is an adequate supply of fuel.
- ✓ Check that the steering system operates properly.
- ✓ Check that the required safety equipment is on-board.
- ✓ Check that the fire extinguisher is fully charged.
- ✓ Check that no fuel, oil or water is leaking or has leaked into the bilge compartment.
- ✓ Check all hoses and connections for leakage and damage.
- ✓ Check that the alternator belt is in good condition.
- ✓ Check that all required **Scheduled Checks and Services** were performed.
- ✓ Check engine drain plugs.
- ✓ Check that the mandatory personal flotation device for each passenger is on-board.

### *During Operation*

- ✓ Check gauges frequently for operating conditions.
- ✓ Check that controls operate smoothly.
- ✓ Check for excessive vibration.

### *After Operation*

- ✓ Fill the fuel tank to prevent moisture resulting from condensation.
- ✓ Check for fluid leaks.
- ✓ For models equipped with a main fuel valve, turn it to the OFF position.
- ✓ Check the fins, propeller, rudder and shaft for damage.\*

\*These tasks are best accomplished while the boat is out of the water.

# New Boat Break-In

---

**NOTE: Failure to follow the break-in procedure exactly as stated will void the engine warranty.**

**T**HE FIRST 20 HOURS OF OPERATION ARE THE MOST IMPORTANT TO YOUR BOAT. Proper break-in will ensure maximum performance and the longest possible power train life. The break-in period allows moving parts within the engine and transmission to *wear-in* properly. All MasterCraft boats are lake-tested on the water before leaving the factory, but the break-in must continue for the first 20 hours of your ownership.



**NOTE: Before operating the boat for the first time, you must read this manual completely.**

Please follow the break-in procedure carefully. Close attention to the following is very important:

- The break-in oil used is 15W40, SAE CG-4SJ. Your technician will use 15W40, SAE CG-4SJ oil in all future oil changes. If the specified preferred oil is not available, 20W50 oil may be substituted, but only if it meets the SAE CG-4SJ standards.
- **Maintain the proper oil level.** Until the piston rings, cylinders and other working internal parts are thoroughly seated, oil consumption can be high and must be carefully watched.
- **Pay close attention to the gauges.** It is important to stop the engine immediately if the gauges indicate a problem. Low oil pressure and overheating are serious and require immediate attention.
- **Abnormal vibration or noises.** These symptoms can precede trouble and should not be ignored. Occasionally, hardware may work loose, mountings may need tightening or the driveline may require attention.

### *First Hour of Operation*

- **Fuel, oil or water leaks.** Leaks can pose a serious safety threat. If one occurs, it is most likely to do so after a few hours of operation.
- **Vary the engine speed.** Never run the engine for more than three (3) minutes at any constant RPM during the break-in period. Doing this will assist in the proper break-in of rings and bearings.
- **Plane the boat quickly.** Operating the boat at low speeds places an excessive load on the engine. Plane quickly, then back down to a slower planing speed.

**1**..... Start the engine and allow the warm-up to normal operating temperature (140°F-to-190°F) at low idle (600-to-800 RPM).

**2**..... Operate the boat in forward gear, accelerate quickly, but gradually, to planing speed. Then return the throttle back to maintain a planing attitude. Vary the engine speed, but do not exceed 2000 RPM for the first hour.

### *Next Four Hours of Operation*

**C**ONTINUE OPERATION AT PLANE AND VARY THE ENGINE SPEED, BUT DO NOT exceed 3000 RPM. Occasionally reduce the throttle to idle speed for a cool-down period.

### *Next Five Hours of Operation*

**C**ONTINUE OPERATION AT PLANE AND VARY THE ENGINE SPEED, BUT DO NOT exceed 4000 RPM. Occasionally reduce the throttle to idle speed for a cool-down period.

### *Next Ten Hours of Operation*

**1**..... Operations during the final ten hours of break-in is very much the same as the second five hours, except that it is permissible to run at full speed for 2-3 minutes at a time. Do not accelerate suddenly from low-to-full speed. Increase speed gradually during this period. Again, an occasional cool-down period is recommended.

**2**..... Return the boat to your MasterCraft dealer for the 20-hour inspection. At this time, your service technician should change the engine oil and filter, as well as making other necessary checks, adjustments and services.

### *After Break-in*

**O**NCE THE BREAK-IN PERIOD IS OVER, THE BOAT MAY BE OPERATED CONTINUOUSLY at any speed, but not beyond the maximum of 5000 RPM.

Always remember that during normal operation you should allow the engine to warm up gradually. Be sure the engine is warm before accelerating. Pay careful attention to the gauges and engine safety warning light. Also, check the oil level frequently during the first 50 hours of operation since the piston rings and cylinders will require that period to seat properly.

After the initial 50 hours of operation, the engine oil and filter must be changed. THIS SECOND OIL CHANGE IS VERY IMPORTANT TO ENSURE A LONG AND TROUBLE-FREE ENGINE LIFE. After break-in, all maintenance is performed at regular intervals.

See the **Scheduled Maintenance Checks and Services** section, beginning on page 44.



**WARNING**

# Starting and Basic Operation

**NOTE: If you are operating this boat for the first time, you must follow the New Boat Break-In procedures as described on pages 27-29. Failure to follow these procedures could result in serious engine damage and will void your warranty!**

## **Before Starting**

**F**AMILIARIZE YOURSELF WITH THE CONTROLS AND INDICATORS USED ON YOUR MasterCraft boat. Perform all **Safety Checks and Services**, as described on page 26. Perform all **Scheduled Maintenance Checks and Services** as described beginning on page 44.

..... Operate the bilge blower for at least four (4) minutes. Leave the bilge blower ON through the starting process and until the boat has planed.

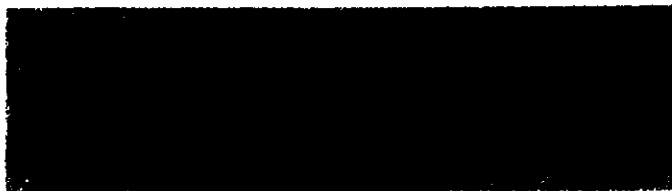

..... If your boat is a SportStar 19 closed bow and is not equipped with the in-tank fuel pump, turn the valve to the ON position.

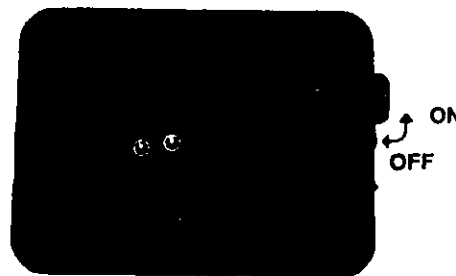

..... Lift the engine cover and inspect the bilge and engine compartment for any fluid leakage. We recommend lifting the engine compartment cover for inspection before each day's use.



**NOTE:** Always start the engine with the control lever in the neutral position or with the shift disengaged. Your boat is equipped with a neutral-start safety switch that will not allow the engine to be started in gear. On EFI engines, if the engine floods, it can be cleared by pulling out the throttle button in front of the handle and advancing the throttle to full open—100 percent of its travel—and turning the key switch to the start position. The ECM shuts off the fuel supply to the injectors so that no fuel will be delivered during the cranking cycle.

When the engine starts, immediately return the throttle to the idle position so that the engine will not over-rev.

■ ..... Attach the Emergency Engine Safety Switch tether (lanyard) between an article of your clothing and the switch.

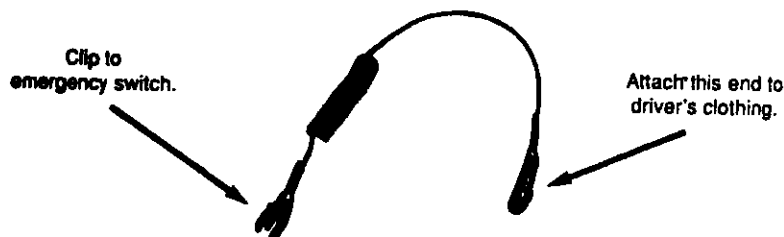

■ ..... For normal starting, leave the throttle lever in neutral. The electronic controls will meter the correct fuel and air automatically.



## Starting the Engine



■ ..... Turn the key switch to the start position and hold until the engine starts. Release the key as soon as the engine starts.

If the engine does not start within 10-15 seconds:

- a. Pull out the Neutral detent, "B" in the figure on page 32.
- b. Advance the throttle lever to wide open throttle, and crank the engine.  
When the engine fires, quickly return the throttle to the idle position.

**NOTE:** While the engine is warming-up, check to see that all lights and gauges operate properly, as well as the steering. There should be no apparent leaks under pressure. Re-engage the control lever after warm-up by returning the lever to neutral and pushing the throttle button back into the engage position.

## Shifting Gears

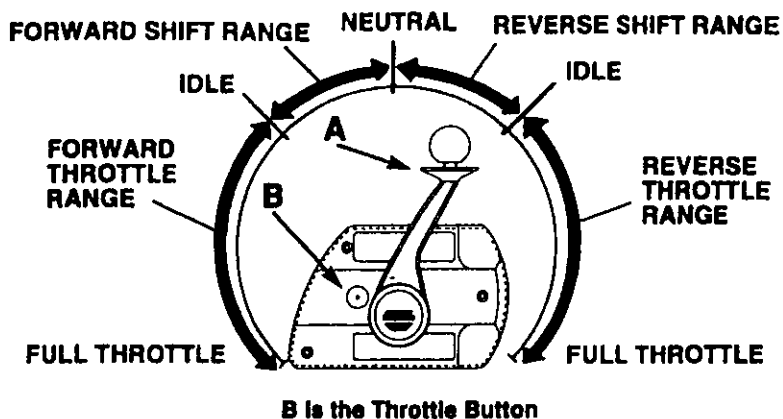

**Forward**—Raise the lifter ball under the lever knob and briskly push the control lever forward into the first 45° of travel. Throttle movement will begin after 45°.

**Reverse**—Raise the lifter ball under the lever knob and briskly pull the control lever back into the first 45° of travel. Throttle movement will begin after 45°.

Once the shift has been completed, continue to move the control lever slowly in the desired direction to increase speed.

**NOTE:** When shifting from forward to reverse or reverse to forward, be sure to stop the control lever in the neutral position and allow the engine to fall between 600-800 RPM before completing the shift.

## Underway

**I**F THE OIL PRESSURE GAUGE INDICATES LOW OR NO OIL PRESSURE, CHECK THE OIL level. If the temperature gauge indicates overheating, check the raw water pick-up for blockage. **DO NOT** operate the boat until the cause for the warning has been found and corrected.



Continued operation after the warning light has illuminated may cause severe engine damage. This will void your warranty.

## ***Stopping***

■..... Slowly bring the control lever to the neutral position. If the boat has been driven for a long period of time at high speed, allow the engine a 2-3 minute cool-down period at low idle (600-800 RPM).

■..... Turn the ignition key to the OFF position to stop the engine.

■..... If any problems were encountered during the operation, have the boat inspected by your MasterCraft dealer. Request any necessary repairs before operating again.

# Operational Hints

## General

**M**ASTERCRAFT URGES YOU—AND ALL OTHERS WHO WILL BE OPERATING THE boat—to seek certified instruction from the local boating authorities.

This section is designed to present the most basic operational principles. It is NOT intended to cover all conditions encountered during operation. Therefore, the principles presented in this manual are limited to the facts related directly to the operation of the boat, while the responsibility for the proper application of these principles belongs to you.

## Loading

**N**EVER OVERLOAD YOUR BOAT. THE MAXIMUM WEIGHT CAPACITY AS listed on the certification plate includes all items added to the boat (persons and gear). Also, proper distribution of weight is critical to boat performance. Allocate the load as evenly as possible.

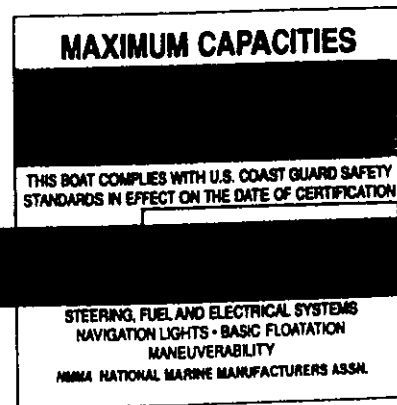
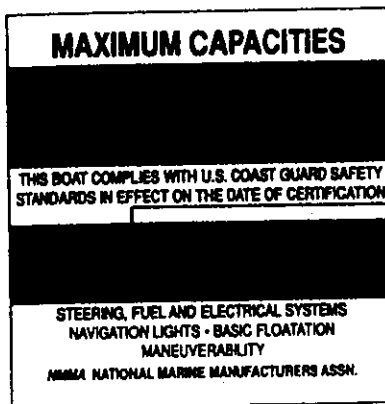

## Emergencies

**K**NOW HOW TO USE AND SPOT DISTRESS SIGNALS—AND OFFER ASSISTANCE IF possible. Remember you may need assistance some day.

## Courtesy

**A**LWAYS RESPECT THE RIGHTS OF OTHERS ON THE WATER. KEEP WIDE WHEN passing, slow down in crowded areas, be alert and be aware of your wake and wash.

**W**HEN TAKING TO THE WATER FOR THE FIRST TIME, YOU MUST KEEP IN MIND A few general guidelines.

## ***First Time Operation***

- **Practice makes perfect!** Start in calm water with no wind or current and plenty of room until you get the feel for the boat and its controls.
- **Proceed slowly!** Give yourself time to think, react and maneuver.
- **Recognize outside forces!** Check the wind direction and velocity, as well as water currents and waves.
- **Have a crew on hand!** Have friends or family ready with fenders, lines and a boat hook to assist you when docking, as well as launching and loading.
- **A boat is not an automobile!** Boats cannot be maneuvered and stopped like a car. Boats steer from the stern (rear) and have no brakes.

**S**TEERING RESPONSE IS DEPENDENT UPON THREE FACTORS: RUDDER POSITION, motion and throttle. While high speed maneuvering is relatively easy and takes little practice, slow speed maneuvering is far more difficult and requires much time and practice to master.

## ***Basic Maneuvering***

With both steering and propulsion at the rear of the boat, the initiation of a turn pushes the stern of the boat away from the direction of the turn. The stern follows a larger turning circle than the bow. This is especially important to remember when making close quarters maneuvers.

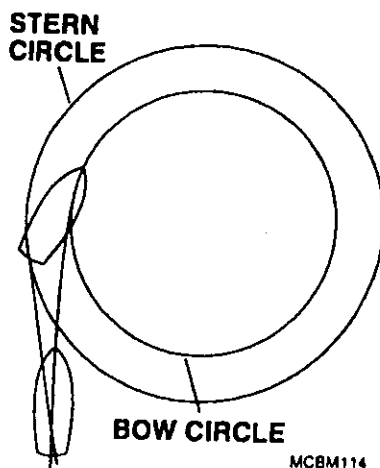

The effects of unequal propeller thrust (torque steering), wind, and current must also be kept in mind. While wind and current may not always be present, a practiced driver will use them to his advantage.

Unequal thrust is a phenomenon shared by all single-engine, propeller-driven boats. A counterclockwise rotation propeller tends to cause the boat to drift to port when going forward, and to starboard when going backwards, with the rudder in the straight-ahead position.

At high speed, there is compensation for this effect and it is virtually nonexistent. But, at slow speed—and especially during backing—the effect can be very powerful. This is the main reason most experienced drivers approach with the dock to starboard of the boat.

Stopping—or checking headway—is a technique that must be mastered. With no brakes, reverse thrust must be used to stop the boat. The momentum of the boat will vary according to the load. Make it a practice to slow to no-wake speed before shifting into reverse.

When practicing maneuvering techniques, always do so in open water that is free of traffic. Adequate practice may make the difference between a pleasurable experience or a damaging—at the least, embarrassing—one.

## **High Speed Operation**

**Y**OUR MasterCraft BOAT WAS DESIGNED TO BE A HIGH PERFORMANCE SKI boat. You may have seen professional drivers with advanced operating skills perform high-speed maneuvers and *on-a-dime* turns. **DO NOT** attempt to duplicate or simulate these feats. Paid, professional drivers log thousands of hours on the water and carefully choreograph every move. Plans are made in advance in the event the routine must be aborted. Maneuvers of this nature could cause serious injury or death, as well as damage to your MasterCraft that will not be covered under warranty.

## **Unusual Operating Conditions**

**I**F THE BODY OF WATER IS UNKNOWN, TALK TO THE LOCAL BOATERS ABOUT THE TYPE of obstacles you may encounter beneath the water's surface. Rocks, tree stumps, sandbars and wing dams are all dangerous and damaging. Be especially wary of rivers and man-made lakes. Rapidly changing conditions can cause daily changes in underwater hazards.

Stay well clear of floating debris. What looks to be a small branch in the water may well turn out to be an entire tree.

When traveling through weedy areas, keep an eye on the engine temperature gauge. Weeds caught-up and blocking the water flow through the raw water intake or transmission cooler will cause trouble. Also, after leaving the weedy area, shift to neutral for a few seconds, and then to reverse for a few seconds to

unwind any weeds that may have wrapped around the propeller.

**A**PPROACH DOCKS SLOWLY, WITH THE STARBOARD SIDE OF THE BOAT IF POSSIBLE. The natural tendency to *torque steer* with the rotation of the propeller at slow speeds makes docking easier on that side. Also, use wind and current to your advantage when docking.

Before tying-up the boat, be sure to use enough dock bumpers to protect the boat from damage. If possible, tie-up with the bow towards the waves. Use good quality double-braided nylon line. Tie-up only to the lifting or tie-down eyes. Never use the handrails or ski pylon.

If the boat is to be moored for a long period of time, use chafing protectors to protect the gelcoat finish. Leave a little slack in the lines, allowing for some wave movement or tidal action where applicable.

If the boat is to be kept in or near the water for the season, consider the purchase of a boat lift. These lifts prevent the build-up of marine growth on the hull as well as protecting from damage typical of on-water storage, such as blistering. Make sure the boat lift supports the hull correctly. See the next section, **Lifting the Boat**.

## **Docking and Tie-Up**

# Lifting the Boat

**W**HEN THE BOAT IS HOISTED FROM THE WATER, USE THE LIFTING EYES OR A sling for easy, damage-free lifting.



## Using Lifting Eyes

**A**N OVERHEAD HOIST WITH 2-TON CAPACITY (MINIMUM) SHOULD BE USED TO LIFT your boat. Cables should be rated for at least 3500 pounds each. When lifting, keep the bow slightly higher than the stern to prevent any possibility of water running into the engine exhaust manifold.

## Using Lifting Slings

**A**N OVERHEAD HOIST WITH 2-TON CAPACITY (MINIMUM) SHOULD BE USED. Slings must be 6-inches-wide-by-20-feet-long and a **minimum capacity of 3500 pounds each**. Use an 8-foot spreader bar on each sling to prevent damaging side pressure to the deck or gunwale molding.



## Storage Cradle

**I**F A STORAGE CRADLE IS USED, THE HULL MUST BE PROPERLY SUPPORTED TO PREVENT load damage. This can occur with as little as 15-pounds-per-square-inch of pressure. **DO NOT** support the boat by resting the hull on the keel. **VERTICAL SUPPORTS MUST EXTEND FROM THE CHINE TO THE KEEL WITH NO GAPS BETWEEN THE HULL AND CRADLE SUPPORTS.** A total support area of at least 250 square inches is required for proper support.

Protect all items extending from the hull from resting on the cradle or the ground. **DO NOT** apply any load stress to the prop, shaft, rudder, swim platform, water intake grate or other protruding items.





 **CAUTION**

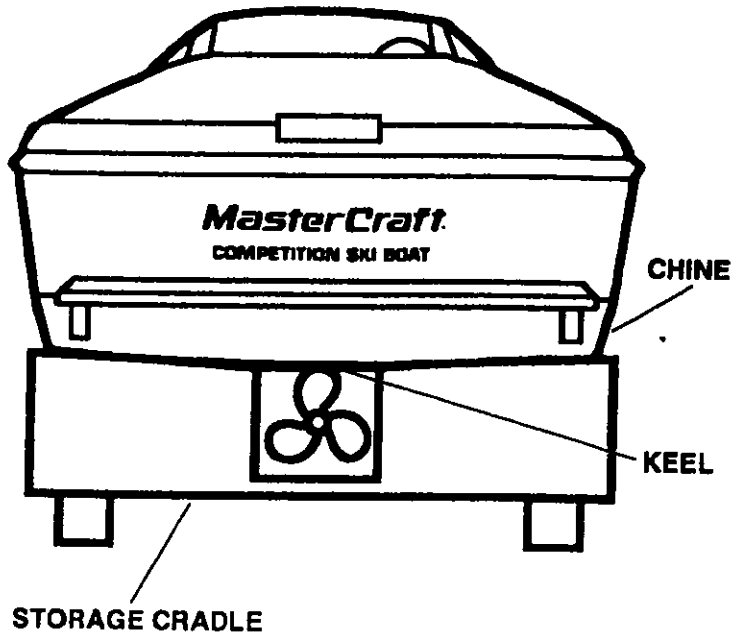

# Corrosion

## Galvanic Corrosion

**G**ALVANIC CORROSION (ELECTROLYSIS) TO THE BOATER IS THE DECOMPOSITION OF metals due to the effects of electrolytic action. When two dissimilar metals are immersed in a conductive fluid (salt water), an electric current is produced, much like the action of a battery. As the current flows, it takes with it tiny bits of the softer metal. If left unchecked, a great deal of damage could occur.

If you operate in salt, polluted or brackish waters, your boat should be equipped with a transom-mounted zinc anode to prevent damage to those metal parts coming in contact with the water. The zinc is, by design, self-sacrificing. It is slowly eroded away by electrolytic action and requires periodic inspection for deterioration.

If the zinc shows extreme erosion, it must be replaced to continue protection, or damage to other metal parts may result.

## Salt Water Corrosion

**Y**OUR BOAT HAS BEEN DESIGNED FOR OPERATION IN FRESH WATER. IF YOU ARE operating temporarily in salt, polluted or brackish water, you will need to flush with fresh water. The entire engine cooling system should be flushed with fresh water for at least 10 minutes after each use. If you operate continuously in salt water, the closed cooling system option is the recommended application.

## Marine Growth

**I**F ACCELERATED MARINE GROWTH IS A PROBLEM IN YOUR AREA, AN ANTI-FOULING bottom paint may be necessary to slow growth while protecting your gelcoat.

Before selecting a bottom paint, talk with other boaters and your MasterCraft dealer to determine which product works best in your area. Many local variables can affect the selection of paint. Be sure to follow the paint manufacturer's directions exactly.

# Cleaning

**P**ERIODIC CLEANING IS THE BEST WAY TO KEEP YOUR BOAT LOOKING LIKE NEW. Regular washing and waxing keep dirt and scum from building up and deteriorating the finish. Keeping your boat in a *showroom-new* condition results in personal satisfaction and higher resale value.

Your boat is made of fiberglass reinforced plastic resin material that is easy to clean and care for. Several layers of resin material are chemically bonded together to form the hull. The smooth outside surface of the hull is a layer of gelcoat resin. While the gelcoat is solid color, the thickness of the layer is only a few millimeters thick—much like paint on a car but much tougher, and chemically bonded.

Beneath the gelcoat surface is a series of layers of chemical resin, fiberglass mat and woven roving. It is these layers that give the boat its strength and keep the hull shape. The boat bottom also uses special core-mat material for its strength-to-weight and superior marine performance.

**W**HEN WASHING THE BOAT, BE SURE TO USE A MILD DETERGENT AND WARM water solution. **DO NOT** use abrasive cleaners, solvents, ammonia or chlorine as these will damage the gelcoat surface. Under extreme conditions, special cleaners may be used to remove marine growth from the hull. See your MasterCraft dealer for further instructions.

Waxing the entire gelcoat surface at least twice a season is recommended for all climates. Use of a specially formulated marine gelcoat wax will prevent color fade, soil and scum adhesion. If the gelcoat has chalked or faded from lack of proper maintenance, buffing may be necessary to bring back the shiny appearance. Hand buffing with a #7 rubbing compound or power buffing with glazing compound #1 will quickly restore the surface.

**R**EGULAR WASHING WITH MILD DETERGENT AND WARM WATER OR AUTOMOTIVE vinyl cleaners is sufficient to keep the cushions and vinyl coverings in good condition. Keep the cushions from becoming soaked and dry thoroughly after washing to prevent mildew accumulation after the boat is covered. Prop up the cushions in the boat when it is covered to take advantage of air circulation. Spray with a mildew repellent.

Hull

Upholstery

While your vinyl is made to withstand the elements, it is important to care for it by keeping it clean at all times. Many substances may stain your vinyl if left on over a period of time. Remember to remove any contaminant and clean vinyl immediately.

Our vinyls are made to withstand the effects of sun, heat, acid rain and soiling, under normal conditions. Please consult these cleaning recommendations before cleaning your upholstery.

Common Stains	Steps	1	2	3
Betadine		B	A	
Chewing Gum		D	A	
Eyeshadow		E	B	
Motor Oil		B		
Spray Paint		B		
Mildew or Wet Leaves*		C	B	A
Shoe Polish*		D	B	
Yellow Mustard		A	B	C
Oil-Base Paint (fresh or dried)		D	B	
Suntan Lotion*		A	B	
Tar/Asphalt		D	B	
Lipstick		A	B	
Latex Paint		A	B	
Crayon		D	B	
Ketchup		A	B	
Grease		D	B	
Ballpoint Ink*		E	B	A
Household Soil		A	B	
Permanent Marker*		E	B	C
Coffee, Tea, Chocolate		B		

**DO NOT USE 409 CLEANER OR SILICONE-BASED PRODUCTS!!!**

- A. Medium-soft brush; warm, soapy water/rinse/dry.
- B. Vinyl finish cleaner.
- C. One (1) tablespoon ammonia, one-fourth (1/4) cup of hydrogen peroxide, three-fourths (3/4) cup of water/rinse/dry.
- D. Wipe or scrape off excess (chill gum with ice).
- E. Denatured alcohol/rinse/dry.

Note: All cleaning methods must be followed by a thorough rinse with water.

\*Suntan lotion, shoe polish, wet leaves and some other products contain dyes that stain permanently.

Certain household cleaners, powdered abrasives, steel wool and industrial cleaners can cause damage and discoloration. These are not recommended for use. Dry cleaning fluids and lacquer solvents should not be used as they will remove the printed pattern and gloss. Waxes should be used with caution because many contain dyes or solvents that can permanently damage the protective coating.

**O**CCASIONAL WASHING WITH MILD DETERGENT AND WARM WATER OR HOUSEHOLD carpet cleaners will keep the carpet clean. Thoroughly hose the detergent out of the carpet and into the bilge. (This is usually the best time to clean the bilge also.) Allow the boat to set uncovered in the sun for several days to prevent any mildew or odor caused by moisture.

## Carpet

**R**EGULAR CLEANING AND OILING OF TEAK WOOD WILL MAINTAIN ITS ORIGINAL appearance. Use a teak cleaner that can penetrate the pores of the wood and cleanse them of dirt and stains. Avoid caustic teak cleaners since they can damage the wood. Immediately after cleaning, an oil sealer should be applied with a soft cloth. Allow a couple of hours for the oil to soak into the wood and apply a second coat. Wipe off excess oil to prevent a varnished look.

## Teak Wood

**C**LEANING THE WINDSHIELD WHEN NEEDED IS AN IMPORTANT SAFETY PRECAUTION. Your MasterCraft windshield is made of tempered safety glass and requires special cleaning to prevent scratches to the surface. Use a mild soap solution and damp cloth only. Harsh detergents, solvents, chemicals or dry cloths could damage the windshield. Also, when your boat is in-service, avoid using the windshield as an aid for balance or getting out of a seat. This causes undue stress on the window frame and could damage it.

## Windshield

**S**TAINLESS STEEL AND CHROME-PLATED PARTS ARE NOT TOTALLY RESISTANT TO corrosion. Occasional cleaning and polishing with a marine chrome-and-stainless polish will maintain and extend the useful life. In salt water areas, rinse all hardware with fresh water and apply a light coating of protective oil to enhance the appearance after each use.

## Stainless Steel and Chrome

**O**CCASIONAL CLEANING OF THE TOP AND COVER SHOULD BE DONE WITH MILD soap and warm water. Thoroughly wet the entire surface and use a soft-bristled brush. Rinse completely and allow to drip dry. Then allow it to lay in the sun until completely dry. After cleaning, treat with a water repellent as necessary.

## Sun Top and Boat Cover

For heavy soil, a mild solution of 1/2-cup bleach, 1/4-cup household soap and one-gallon of water may be used for soaking. DO NOT allow to soak for more than 20 minutes—longer will cause deterioration of the stitching. Rinse completely and allow to drip dry. Then follow up with time in the sun until it is completely dry.

# Scheduled Maintenance Checks and Services

**P**ROPER CARE, MAINTENANCE AND ADJUSTMENT WILL CONTRIBUTE TO THE PEAK performance of the boat, while also extending the overall service life and the resale value.

Use the following information to establish your maintenance routine. The instructions are grouped by the required service intervals. The pages that follow also provide instructions on how to accomplish the required checks, inspections and services listed. Your MasterCraft dealer or service center is the best source for proper maintenance.

The following definitions apply to maintenance:

**Check**—Verify the operational readiness by physical measurement, i.e., measuring the oil level with the dipstick gauge, or alignment with a feeler gauge.

**Inspect**—Determine the operational readiness by examination, i.e., by sight, sound or feel.

**Change**—Tasks required periodically to keep the boat in proper operating condition, i.e., drain, replenish or service.

## Frequency and Scheduled Maintenance

**New Boat Break-In**  
*MasterCraft recommends these functions be performed by factory-trained MasterCraft technicians*

- ✓ Change the engine oil and filter after the initial 20 and 50 hour mark of operation. Use only manufacturer's recommended lubricants. (See **Quarterly and Annual Maintenance**.)
- ✓ Lubricate the engine starter drive gear and shaft. (See **Quarterly Maintenance**.)
- ✓ Check the alignment of the propeller shaft coupling. (See **Annual Maintenance**.)

## Before Each Use (Every 8 Hours)

- ✓ Check the engine oil level.
- ✓ Check the transmission fluid level.
- ✓ Check the cooling system level (fresh-water-cooling-equipped boats only).
- ✓ Check the engine belts for looseness or damage.
- ✓ Inspect the drive train for loose or missing hardware.\*
- ✓ Inspect the throttle and shift cables for kinks, wear and interference with other components.
- ✓ Inspect the battery connections and hold-downs.
- ✓ Inspect the exhaust system for leaks.
- ✓ Inspect the propeller shaft log for excessive water entry.
- ✓ Inspect the fuel system lines and connections for leakage.
- ✓ Inspect the the intake water strainer and transmission cooler for blockage.
- ✓ Inspect the raw water impeller if the boat showed signs of overheating during the last operation.

- ✓ Change the engine oil and filter.
- ✓ Lubricate the engine starter drive gear and shaft.
- ✓ Check the safety equipment.

**Quarterly**  
**(Every 50 Hours)**  
**MasterCraft recommends**  
**these functions be**  
**performed by factory-**  
**trained MasterCraft**  
**technicians**

- ✓ Change the engine oil and filter.
- ✓ Clean the engine flamer arrestor.
- ✓ Replace the fuel filter (*trained technician-only function due to pressure in-line*).
- ✓ Perform an engine tune-up.
- ✓ Change the transmission fluid.
- ✓ Clean the battery terminals.
- ✓ Replace the raw water impeller.
- ✓ Check the propeller shaft coupling alignment.
- ✓ Lubricate the steering system.
- ✓ Lubricate the throttle and shift cables.
- ✓ Inspect the exhaust flaps for damage.\*
- ✓ Check the engine mounts.
- ✓ Inspect the complete fuel system for leakage.

**Annually**  
**(Every 100 Hours)**  
**MasterCraft recommends**  
**these functions be**  
**performed by factory-**  
**trained MasterCraft**  
**technicians**

 ..... With the engine OFF and the engine safety starting switch disconnected, be certain the the throttle/shift control lever is in neutral. Open the engine box.

 ..... Loosen the clamp surrounding the water intake hose at the back end of the transmission cooler and slide the hose off. Check the screen for signs of debris, which must be removed. The screen is permanently in place and your boat must not be operated with any foreign materials blocking the flow of water through the cooler.



 ..... After cleaning, re-attach the hose and clamp.

**Before Each Use**  
**(Every 8 Hours)**

**IMPORTANT: This is a critical function of routine maintenance. Even clean-appearing waterways may have debris such as pine needles or moss that can enter the cooling system and create a blockage against this screen. Failure to perform this function can result in serious overheating of the engine. Damage to the engine caused by overheating is not covered by warranty! Always pay attention to your temperature gauge, even if you are carefully performing this check.**

## Check Engine Oil Level

\*Recommended to be performed with the boat out of the water.

..... Operate the engine at idle while in the water for about 3 minutes or until warm. Turn the engine OFF and disconnect the engine safety starting switch.

..... Open the engine compartment box and locate the engine oil level dipstick.

..... Remove the dipstick and wipe off. Re-insert the dipstick fully and immediately remove. Check that the oil level is between the *ADD* and *SAFE* marks on the dipstick.

..... Add oil if necessary through the oil filler in the valve cover. Use only the recommended automotive type motor oil. See **Specifications** on pages 70 and 71. Never mix different types or brands of oil.

## Check Transmission Fluid Level

..... Operate the boat for about 5 minutes to warm the transmission fluid. Turn the engine OFF and disconnect the engine safety starting switch. Be sure that the throttle/shift control level is in neutral.

**NOTE: The transmission fluid level must be checked immediately after engine shut-down to prevent an incorrect reading. Fluid drains back into the transmission from the cooler and cooler lines, and the dipstick could give a false reading if not done quickly.**

..... Open the engine compartment box and locate the transmission fluid level dipstick.

..... Remove the dipstick and wipe off with a clean rag. Quickly re-insert the dipstick fully and immediately remove. Check that fluid level is at the *FULL WARM* mark on the stick.

..... Add or remove fluid as necessary to maintain the level at the mark. Use only the recommended automotive transmission fluid. See **Specifications** on page 71. Never mix different types or brands of fluid.

## Check Cooling System Coolant Level (for closed-cooling system)

..... Open the engine compartment box and remove the reservoir cap.

..... Maintain coolant level to the top of the reservoir filler neck.



**CAUTION**





Turn the engine OFF and disconnect the engine safety starting switch. Be sure that the throttle/shift control lever is in neutral.

Open the engine compartment box and locate the engine belts.

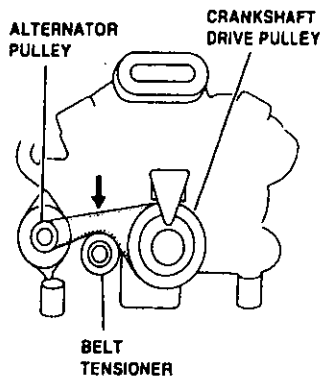

### Check Engine Belts for Looseness or Damage

Check the alternator belt tension at the top, midway between the circulating pump pulley and the alternator pulley. The belt should be tight enough so that it will deflect 1/4"-1/2" when pressed with the thumb.

If the belt needs adjustment on the MasterCraft Vortec MX Plus engine, loosen the alternator mounting hardware, pivot the alternator as needed, and tighten the hardware. Re-check the belt tension. On engines set up with serpentine belt systems, no change is necessary. Belt tension is maintained by the automatic belt tensioner.

**NOTE: If the belt is too tight, excessive belt and bearing wear can occur. If the belt is too loose, slippage can occur, resulting in low alternator output and rapid belt wear.**

Due to the complexity and potential danger, MasterCraft recommends that this work be completed by your dealer.

### Check/Service Fuel Filters

On the SportStar 19 closed bow model, there are two in-line fuel filters on your boat. One is on the line near the engine, while the other is near the fuel tank. Both should be regularly serviced; this is critical to maintaining your engine. Again, MasterCraft recommends the work be completed by your dealer.

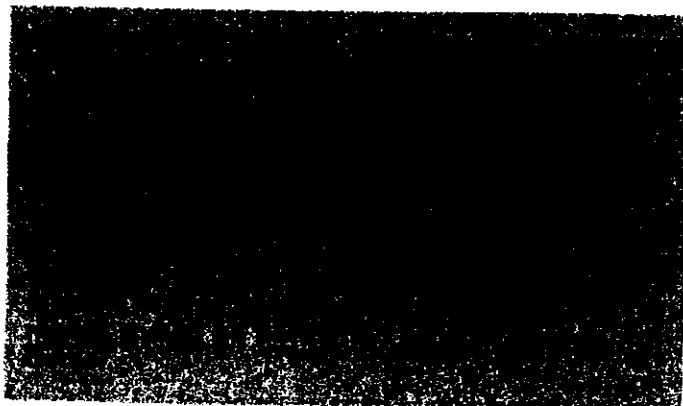

 **WARNING**

## Inspect Engine for Loose or Missing Hardware

..... Turn the engine OFF and disconnect the engine safety starting switch. Be sure that the throttle/shift control lever is in neutral. The engine must be cool.

..... Thoroughly and systematically check the entire engine for loose and missing hardware by sight. Try to shake components such as the alternator by hand. If a looseness problem persists, see your MasterCraft dealer.

## Inspect Throttle & Shift Cables for Kinks, Wear and Interference

..... Turn the engine OFF and disconnect the engine safety starting switch. Be sure that the throttle/shift control lever is in neutral. The engine must be cool.

..... Open the engine compartment and locate the throttle and shift cables. Follow each cable back under the floorboards and feel for kinks and wear on the outer jacket. Any sign of cable damage is cause for replacement. See your MasterCraft dealer.

## Check Impeller When Necessary

..... If the engine exhibited any signs of overheating or excessive heat when it was last run or when it is turned on this time, check the raw water pump impeller. Failure to maintain the impeller in excellent condition can cause serious engine problems and may void your warranty.

## Inspect Battery Connections and Hold-downs

..... In both the ProStar and SportStar lines of MasterCraft boats, the battery is located under the seat across from the driver's. See the illustrations.

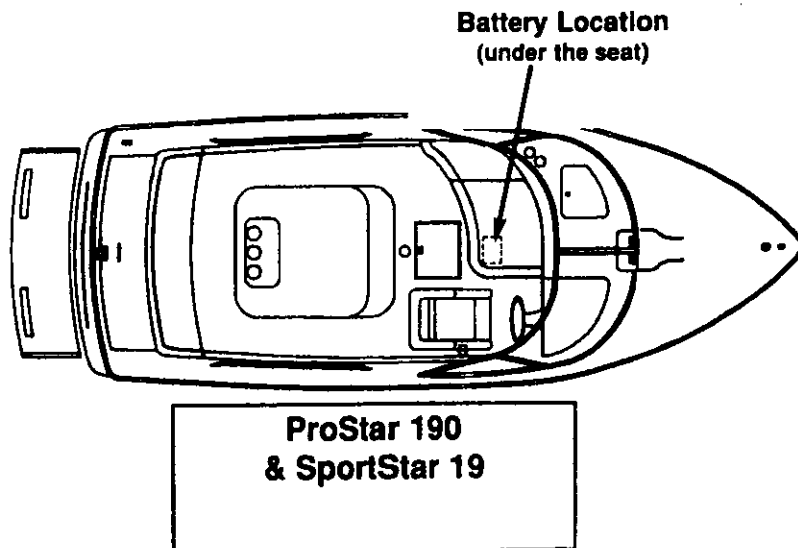

**ProStar 195 and 205**  
(also located under seat in 205 V-drive)

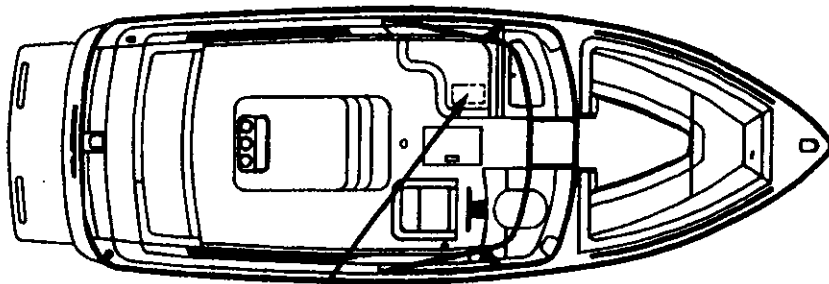

**Battery Location**  
(under the seat)



 **WARNING**

..... Check that the battery post connections are clean and tight.

**IF NOT:**

- Loosen and remove the negative terminal connection first. Be careful not to touch the positive terminal with the wrench.
- Loosen and remove the positive terminal connection.
- Remove battery hold-downs and remove the battery from the boat.
- Clean corrosion from the battery posts with a battery terminal cleaner. Clean the battery with a water-and-baking-soda solution. **Use care to avoid allowing the solution to enter the battery vents.** Rinse the battery with fresh water.
- Use a battery terminal cleaning brush to remove corrosion from the inside of the battery terminals. Clean the terminals with a water-and-baking-soda solution and rinse.
- Reconnect the positive terminal first, and then the negative. Tighten the terminals. Coat both terminals completely with a thin covering of marine grease. Be sure that the rubber boot covers the positive terminal completely.

## Inspect Exhaust System for Leaks



### WARNING

## Inspect Propeller Shaft Log for Excessive Water Entry

1..... Turn the engine OFF and disconnect the engine safety starting switch. Be sure that the throttle/shift control lever is in neutral. The engine must be cool.

2..... Open the engine compartment and visually check the exhaust system from the engine to the transom for obvious damage.

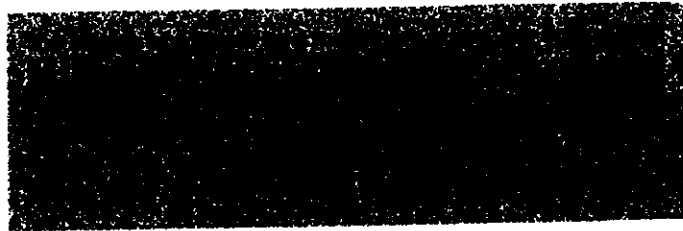

3..... Start the engine with the engine compartment open.

4..... Check the hose connections between the exhaust manifolds and the mufflers for leakage.

5..... If leakage is apparent, tighten the hose clamps, being careful not to crimp the hose. See your MasterCraft dealer for parts and service.

1..... Turn the engine OFF and disconnect the engine safety starting switch. Be sure that the throttle/shift control lever is in neutral.

2..... With the boat in the water, open the engine box and check for leakage while the engine is off. No leakage is permissible while the engine is OFF. See also **Check Propeller Shaft Coupling Alignment**, beginning on page 54.

3..... Start the engine, and with another person operating the boat, inspect the shaft log for leakage. 10-to-15 drops of water per minute is normal. If the water entry is excessive, however, adjust the packing-gland nut. To adjust:

- Turn the engine OFF.
- Loosen the packing-gland lock nut.
- Hand-tighten the packing-gland nut, and re-tighten the lock nut.
- Operate the boat again and check for the proper adjustment. If the water leakage continues, the shaft log must be re-packed. If it continues to be a problem, see your MasterCraft dealer.

..... Turn the engine OFF and disconnect the engine safety starting switch. Be sure that the throttle/shift control lever is in neutral. The engine must be cool.



..... Open the engine compartment box and visually check the fuel system from the fuel pump to the fuel rails and injectors for obvious leakage.



..... Start the engine and look for leakage. Stop the engine immediately if leakage occurs. The leak must be repaired before the engine is restarted. See your MasterCraft dealer.

**M**asterCraft RECOMMENDS THAT YOUR QUARTERLY—OR 50-HOUR—MAINTENANCE requirements be performed by your MasterCraft dealer. Their staff has the proper equipment and technical training to best meet your service needs.

..... Start and run the engine until it is warm. Turn the engine OFF and disconnect the engine safety starting switch. Be sure that the throttle/shift control lever is in neutral.

..... Open the engine compartment and locate the oil drain hose, which runs from the bottom of the oil pan along the port side of the engine. At the end of the oil drain hose is a brass plug.

## Inspect Fuel System for Leaks



## Quarterly (Every 50 Hours)

### Change Engine Oil

**NOTE:** Never drain oil into the bilge or into the water. Wipe up any spilled oil immediately, and dispose of the rags and drained oil properly on-shore.



*MasterCraft Fun!*

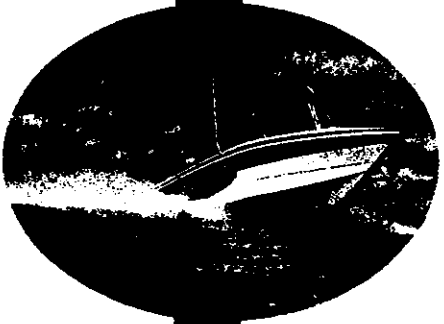
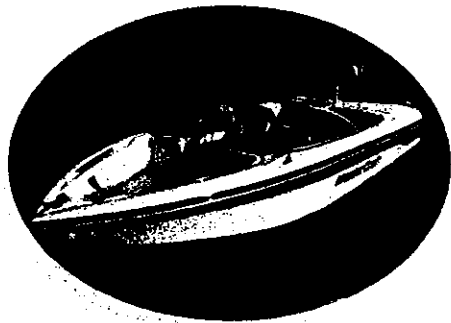
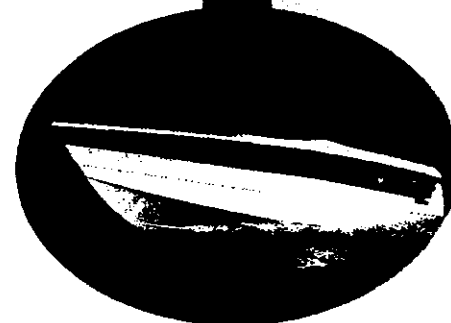

1..... Remove the engine oil filler cap located on the valve cover. This will speed-up the oil draining process.

2..... Attach a suction pump to the drain hose and remove the oil completely. If the boat is on the trailer, it may be easier to remove the bilge drain plug and drop the drain hose through the hole. Drain oil into a container on the ground.

3..... The filter should be changed each time the oil is changed. Remove the oil filter and dispose of it properly on-shore.

4..... Lightly lubricate the filter gasket of the new filter with clean motor oil.

5..... Replace your oil filter with a new one from MasterCraft. Screw on the filter by hand until the gasket just touches the block, then tighten it one-half turn more by hand. DO NOT use a filter wrench to tighten.

6..... Re-attach the oil drain plug to the end of the hose and refill the crankcase through the filler opening. Check the oil level with the dipstick. If this is the initial quarterly oil change, re-attach a cable tie around the oil drain hose and the water line on the port side of the engine, as it came from the factory, to keep the line from coming in contact with any hot areas.

7..... After filling the engine with oil, start the engine and check the area around the filter for leaks.

**NOTE: The engine oil recommendation for all engines is SAE 15W-40 oil, rated at CG-4SJ. This rating requires oils to have higher additive levels than typical gasoline engine oils. This provides a higher viscosity to compensate for potential thinning or fuel dilution. Any other rating other than CG-4SJ may result in damage or excessive wear to the engine and should be avoided.**

 **CAUTION**

**Lubricate Engine  
Starter Gear  
and Shaft**

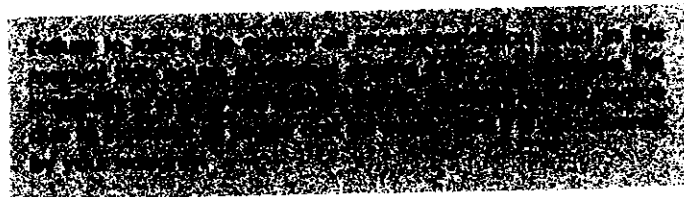

1..... Turn the engine OFF and disconnect the engine safety starting switch. Be sure that the throttle/shift control lever is in neutral. The engine must be cool.

2..... Disconnect the negative (—) battery terminal.

■..... Open the engine cover and locate the starter on the lower starboard side of the engine.

■..... Disconnect the starter and carefully remove it from the engine.

■..... Lubricate the starter bendix with a light coating of spray lubricant such as WD 40 or LPS 1.

**S**OME BOAT OWNERS CHOOSE TO EXECUTE THESE TASKS AS PART OF A WINTERIZATION process or during the off-season, but regardless of the seasonal timing, this should be performed at least once a year. Additionally, MasterCraft recommends that you change your oil and filter prior to storage. (Follow the instructions outlined on pages 51 and 52 for changing the oil and filter.)

**M**ASTERCRAFT RECOMMENDS HAVING THE ENGINE FLAME ARRESTOR INSPECTED and cleaned by your dealer immediately prior to starting the boating season. This procedure is extremely important and should be performed at least once each year.

**C**HANGE THE RAW WATER PUMP IMPELLER ANNUALLY. THIS IS EXTREMELY important. Through normal wear and tear, the impeller usually lasts no more than one season. If it does not function properly, and it will not when worn, it can cause serious engine overheating and potentially void your warranty! This should be done by your MasterCraft dealer.

**A** COMPLETE ENGINE TUNE-UP, WHICH INCLUDES REPLACEMENT OF THE PCV valve, spark plugs, distributor cap, rotor and ignition wires (if needed) should be performed annually. Also, adjustments for spark, dwell and idle should be included. All of these functions require special knowledge, tools and test equipment.

For this reason, MasterCraft recommends having the engine tune-up performed by your dealer.

■..... Run the boat to bring it to normal operating temperature. Turn the engine OFF and disconnect the engine safety starting switch. Be sure that the throttle/shift control lever is in neutral.

■..... Open the engine cover and locate the transmission.

■..... Remove the transmission dipstick.

**Annually**  
**(Every 100 Hours)**

**Clean Engine  
Flame Arrestor**

**Replace Raw  
Water Pump  
Impeller**

**Engine Tune-Up**

**Change  
Transmission  
Fluid**



## Check Propeller Shaft Coupling Alignment

**4**..... Use a suction pump through the transmission fluid filler opening to remove fluid from the transmission casing.

**5**..... Refill the transmission with fluid through the filler opening. See **Specifications**, page 71, for capacities and recommended fluid type.

**1**..... Turn the engine OFF and disconnect the engine safety starting switch. Be sure the throttle/shift control lever is in neutral. The engine must be cool.

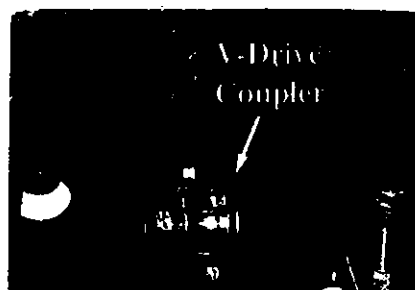
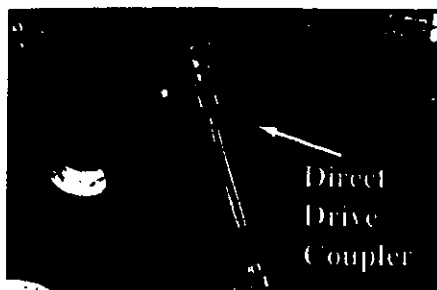

**2**..... Open the engine cover and locate the propeller shaft coupling.

**3**..... Remove the coupling bolts and slide the coupling apart only slightly so that the pilot flange on the propeller shaft side is still seated in the pilot bore of the transmission side.

**4**..... Using a feeler gauge, measure the gap between the coupling halves at four places, such as 12, 3, 6 & 9 o'clock. Rotate the coupling flanges together, stopping every 90° to check clearance with the gauge at each of the four locations again, using the feeler gauge.

**5**..... Alignment is satisfactory when the flanges are parallel within 0.003 inch.

**6**..... If the alignment is not satisfactory, an adjustment must be made. Special tools and procedures are required for proper adjustment and should only be made by a trained MasterCraft technician. See your MasterCraft dealer.

**7**..... If alignment is satisfactory, re-install the flange bolts and tighten securely.

**8**..... Water test to ensure that there is no vibration. If a vibration is noticeable, see your MasterCraft dealer immediately.

**1**..... Turn the engine OFF and disconnect the engine safety starting switch. Be sure that the throttle/shift control lever is in neutral. The engine must be cool.

## Lubricate Steering System

- ..... Remove the access panel in the rear trunk compartment.
- ..... Turn the steering wheel so that the maximum amount of steering cable is seen.
- ..... Use solvent to clean old lubricant from the cable end, pivot and rudder shaft.
- ..... Spread a generous amount of waterproof marine multi-purpose grease over the cable end. Work the steering wheel back and forth and re-apply grease, if necessary.
- ..... Using the flexible end on a grease gun, give two full shots of waterproof marine multi-purpose grease to the three grease fittings: one on the rudder shaft, one on the tube and one on the pivot. Clean up any old grease purged from the areas.

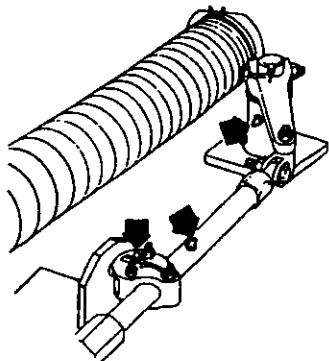

MCBM127

- ..... Rotate the steering wheel back and forth several times to work lubricant in.
- ..... Install the floorboard and rear seat.
- ..... Turn the engine OFF and disconnect the engine safety starting switch. Be sure that the throttle/shift control lever is in neutral. The engine must be cool.
- ..... Open the engine box and locate the shift and throttle cable ends.
- ..... Shift to full-throttle-forward.
- ..... Lubricate the cable ends and connections with a coating of waterproof marine multi-purpose grease.
- ..... Lubricate the pivots and linkages with a light grease.

## Lubricate Shift and Throttle Cables

## Inspect Exhaust Flaps for Damage

## Check Engine Mounts

## Inspect Complete Fuel System for Leakage

6..... Shift the control lever from full-throttle-forward to full-throttle-reverse several times to work the lubricant in.

1..... Turn the engine OFF and disconnect the engine safety starting switch. Be sure that the throttle/shift control lever is in neutral.

2..... Inspect the exhaust flap hinge for signs of deterioration. Replace the flaps if necessary.

1..... Turn the engine OFF and disconnect the engine safety starting switch. Be sure that the throttle/shift control lever is in neutral. The engine must be cool.

2..... Open the engine box and locate the four motor mounts.

3..... Check the tightness of the mounting hardware and adjustment lock-nuts. Tighten any loose hardware securely.

Although your boat engine is similar to your automobile engine, the engine compartment differs substantially. The underside of your automobile engine compartment is totally open to the atmosphere. This allows complete air circulation and ventilation. Your boat engine is housed in a closed compartment, the underside of which is the bottom of the boat.

The enclosed engine compartment limits the ventilation of gasoline and oil fumes. Because confined gasoline vapors mixed with a little air can form an explosive atmosphere, it is important to be especially vigilant in performing the following two operations:

1..... Run your bilge blower at least four minutes to ventilate the bilge area each time before starting the engine.

2..... Inspect your boat bilge area under the engine for the evidence of oil and gasoline—or any gasoline odor. This inspection should take place the first time the boat is started each day. Raise the engine cover and visually look at the bilge area under the engine.



### WARNING

Gasoline is explosive. If you see or smell the presence of gasoline during any inspection, DO NOT START YOUR ENGINE. Remove the ignition key from the ignition switch and call your MasterCraft dealer for service. Your MasterCraft should be scheduled for a fuel system inspection at least twice during each boating season—once during the spring service and an additional check during the boating season.

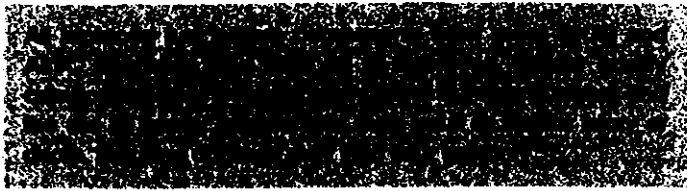

**WARNING**

**NOTE: If you notice loose fuel fittings, deteriorated lines or other problems associated with the fuel system, call your MasterCraft dealer. Fuel system service requires special service tools and special training.**

**NOTE: Throughout the instructions for maintenance, from break-in to annual, you have been instructed to disconnect the engine safety starting switch. In every instance, you must re-connect it after completing the maintenance procedures. Otherwise, your boat will not start nor run.**

# Unscheduled Maintenance

## Changing Propellers

**Y**OUR BOAT HAS BEEN FITTED WITH A PROPELLER THAT OFFERS THE BEST OVERALL combination for top performance. Still, it may be necessary at times to change the propeller to meet certain operating conditions, such as more speed (at the expense of torque) or more torque (at the expense of speed). In any case, consult your MasterCraft dealer for specific recommendations.

New propellers should be fitted to the shaft while it is out of the water to assure good contact. To replace and fit a propeller, use these procedures:

**1**..... Turn the engine OFF and disconnect the engine safety starting switch. Place the throttle/shift control lever in forward gear.

**2**..... Remove and discard the cotter pin.

**3**..... Remove the propeller nut.

**4**..... Using a propeller puller, pull the old propeller off the shaft. Remove the key from the shaft keyway. Inspect the key for damage. Discard if damaged. Propellers may be purchased from your authorized MasterCraft dealer.

**5**..... Use a honing stone to remove any small burrs or nicks from the tapered end of the propeller shaft.

**6**..... Apply a thin layer of "Prussian Blue" to the tapered area of the propeller shaft.

**7**..... Install the new propeller on the shaft without the key and rotate it slightly from side to side. Remove the propeller.

**8**..... Inspect the tapered area of the shaft. Where the propeller contacts the shaft the bluing will be gone. At least 60 percent contact is required. If the contact area is sufficient, go to Step 11.

**9**..... If the contact area is too small, apply a coat of coarse lapping compound to the taper area of the shaft. Install the propeller and rotate it on the shaft at least 100 times. Alternate every 10 revolutions between clockwise and counterclockwise rotation.

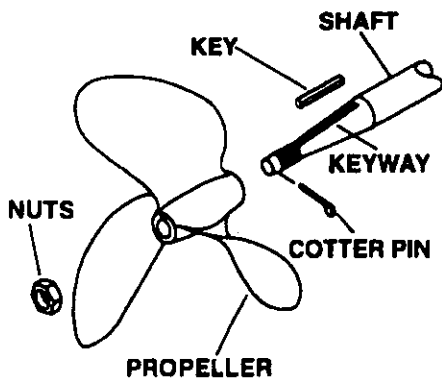

MCBM128

Remove the propeller and use a solvent to clean the lapping compound from the propeller and shaft. Repeat Steps 6, 7 and 8.

Thoroughly clean and apply a light coat of waterproof marine multi-purpose grease to the taper area of the shaft and propeller.

Install the key into the keyway of the shaft. The key should fit tight from side to side in both the shaft and the propeller.

Install the propeller on the shaft, aligning the keyway with the key in the shaft. There should be a small amount of clearance between the key and propeller keyway. If there is no clearance, the propeller may be forced off center, causing a vibration.

Install the propeller nut and torque to 50-ft-lb.

Install a new cotter pin and bend the ends around the shaft to lock the propeller on the shaft.

**P**ROPELLER DAMAGE IS CAUSED BY STRIKING SOLID OBJECTS. IF THE PROPELLER IS not rotating, usually only one blade is bent, and it is difficult to see. If the propeller is rotating when it strikes an object, usually damage can easily be seen on all the blades. To check for a bent blade(s):

Turn the engine OFF and disconnect the engine safety starting switch. Place the throttle/shift control lever in forward gear.

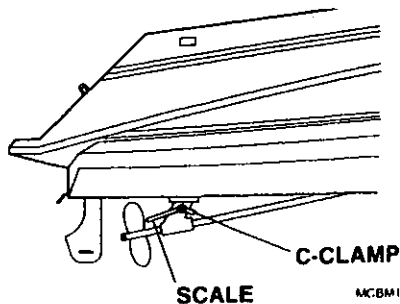

MCBM199

## Checking/ Repairing Propellers

## Speedometer Calibration

**1**..... Clamp a small rule scale to the shaft strut parallel to the shaft so that the end of the scale is  $\frac{3}{32}$ -inch from the leading edge of a propeller blade.

**2**..... Rotate the propeller slowly. There should be no more than  $\frac{3}{32}$ -inch variance between the blades. If the propeller is damaged, see your MasterCraft dealer.

To repair minor nicks and dings in a propeller:

**1**..... Remove the propeller from the boat.

**2**..... Use a small ball-peen hammer and anvil to carefully pound out the ding to the original contour of the blade.

**3**..... File the area to remove rough edges.

**4**..... Re-install as outlined in checking propellers, and if a vibration is detected, have the propeller replaced. Do not use a propeller that is the source of a vibration. **Further drivetrain damage could result, and this will not be covered under warranty!**

**F**OR TOURNAMENT USE AND PRACTICE, ACCURATE SPEEDOMETER READINGS ARE A must. To calibrate the speedometer you need an accurately measured course of 850 feet and a certified stopwatch accurate to a thousandth of a second. To calibrate to AWSA official-tournament rules:

**1**..... Approach the course at an indicated 36 miles per hour (MPH). Hold the speed steady and have an observer check the course time with a stopwatch.

**2**..... If the course time is between 15.88 and 16.28 seconds, no adjustment is necessary.

**3**..... If the course time is not within tolerance, the adjustment is on the column rocker switch (right panel). The switches are (in order from left) the left speedometer, the clock set button and the right speedometer. By pressing up or down, you adjust the calibration.

**L**OOSEN, BUT DON'T REMOVE THE SCREW AT THE BACK OF THE LIGHT. POP THE top chrome piece off. Push down and turn the red-and-green lens. Remove the bulb and replace it.

During re-installation of the bow light lens, be sure that the red lens is to the port side of the boat and the green lens is to starboard. Snug-up the screws—do not over-torque.

**U**NSCREW THE LENS COVER COUNTERCLOCKWISE 1/8-TURN. THE COVER WILL lift off. Remove the bulb and replace it. Reassemble, using care to avoid stripping the screws.

**T**HE OPTIONAL RADIO HAS TWO INLINE FUSES; ONE ON THE POWER (POSITIVE) wire, and one on the memory wire. In-line fuses are located underneath the instrument panel. To open an inline fuse holder, grasp each end of the holder, push together and twist in opposite directions.

Radio Power	ATC	3 Amp
Radio Memory	ATC	5 Amp

## **Replacing Lights**

### **Bow Light**

### **Stern Light**

## **Replacing Fuses**



# Storage/Winterization

**S**TORAGE OR WINTER LAY-UP REQUIRES SPECIAL PREPARATION TO PREVENT DAMAGE to the boat. Since winter storage is an annual event, it presents an excellent opportunity to perform the annual maintenance at this time.

Without proper preparation, storage for long periods of time may cause internal parts of the engine and transmission to rust because of lack of lubrication. Also, if the boat has been stored in below-freezing temperatures, with water inside the bilge or engine cooling system, including the heater or shower, this condition could result in major damage from freezing. Damage to the boat due to improper storage will void the warranty.

The following procedures will help keep your boat from damage for a period of no longer than 5 months.



## WARNING

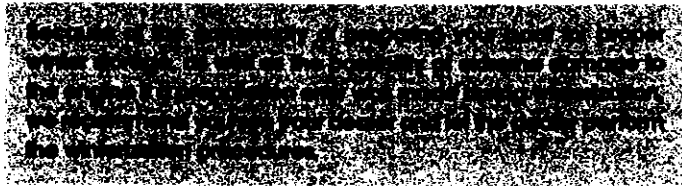

### *While the Boat is Still in the Water*

- 1**..... Fill the fuel tank and add 1 ounce of STA-BIL<sup>®</sup> gas stabilizer for each 5 quarts of gasoline (4 oz. per 5 gallons).
- 2**..... Operate the boat for at least 15 minutes in water or using a flush system to enable the treated fuel to reach the engine.
- 3**..... Add a lightweight engine oil (SAE-10—commonly referred to as fogging oil—or Marvel Mystery Oil) slowly into the engine while the engine is slightly above idle. Cut the engine off.

**NOTE:** If you do not have a MasterCraft trailer for your boat, you should consider a storage cradle. If the hull is supported improperly for a period of time, a great deal of hull damage can occur. MasterCraft trailers are designed to give your boat proper support for long term storage. See *Lifting the Boat*, beginning on page 38, for more information on storage cradles.

## **When the Boat Is Removed from the Water**

1. Remove the bilge drain plug immediately after taking the boat out of the water. After a general bow to stern washing, raise the bow of the boat higher to allow as much water as possible to drain while performing other storage preparations.
2. Thoroughly clean the hull, deck and interior of the boat as soon as it is removed from the water. Cleaning at this time is easier because any marine growth is still wet. Be sure to allow a few days of air drying to prevent mildew that results from trapped moisture. (See **Cleaning**, beginning on page 41.)
3. Apply a coat of wax to the entire surface of the boat.
4. Remove the attaching hardware from the propeller shaft coupling. Separate the flanges and coat the flange surface with waterproof marine multi-purpose grease.
5. Flush the engine cooling system with clean water. **DO NOT** exceed 1500 RPMs while flushing for 5-10 minutes.
6. Turn the fuel supply line ON-OFF valve to OFF. Perform all scheduled maintenance. Of special importance is tuning the engine and changing the oil and fuel filters.
7. Remove the exhaust manifolds' drain plugs. Refer to the General Layout on pages 16 & 17 for assistance in determining the location.
8. The use of automotive-type ethylene glycol antifreeze is not recommended unless you have facilities to properly re-cycle this compound. The use of environmentally-safe anti-freeze and propylene glycol-type anti-freezes—meeting GM 1825M performance specification—is allowed. Remove the petcock or drain plug at the lower side of the engine block. An engine drain is located on both sides of the engine. Our models have a knock sensor located in a drain location. The knock sensor must be carefully removed to allow the engine to drain.

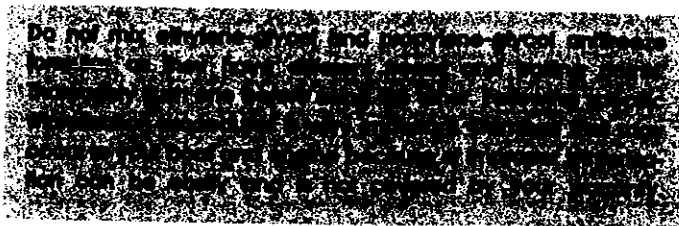

9. Remove both hoses from the raw water pump. Remove the 2-1/2" hose running from the thermostat housing to the circulation pump (at the pump). Also remove the 1-1/4" hose from the lower end of the transmission cooler. **Leave all hoses disconnected during transporting or storage. Bend/shake hoses as necessary to remove water droplets.**



**NOTE: Be sure that hoses will not become entangled in the engine V-belt when the engine turns over or the hose and/or the belt will be damaged.**

**10**..... Remove the ignition safety switch and spin the engine over for a few seconds to remove excess water found in pump bodies.

**11**..... Remove the negative battery cable from the battery. Charge the battery to full-charge or remove completely. **Never store batteries close to heat, spark or flame-producing devices.**

**12**..... Clean all traces of dirt, oil grime and grease from the engine, transmission and bilge. Touch up areas of the engine and transmission where paint has been removed.

**13**..... If the boat is to be stored for more than two months in a high-moisture environment, in temperature extremes or outdoors, *fog* the engine with a rust-preventative fogging oil. Consult your dealer for this.

**14**..... Coat the entire length of the propeller shaft (inside and outside the boat) with corrosion-resistant metal protectant.

**15**..... Use duct tape to seal the exhaust flaps to prevent dirt and nesting rodents from entering.

**16**..... Check to see if the speedometer pick-ups in the rear of the boat are clogged. If so, damage can occur to the speedometer ballast tubes.

**17**..... If your boat is equipped with an optional heater or shower, remove both hoses and blow through a hose to remove all water.

**18**..... Cover the boat with a boat cover or tarp.

**NOTE: If the boat is to be stored outside and subject to accumulations of snow, water and ice, a support should be made for the boat cover so that it will not sag, rip or tear, thereby allowing water to enter the boat. Two-inch PVC plumbing pipe is ideal for this purpose. It is readily available at local hardware stores, and it is easy to work with. Also, its rounded shape will prevent damage to the canvas.**

### **Re-activating the Boat After Storage**

**1**..... Remove the duct tape from the exhaust flaps.

**2**..... Charge and install the battery in the boat, following all safety precautions associated with changing batteries.

..... Re-connect the composite plastic manifold exhaust drain hoses.

..... Close the engine drain petcocks or re-install the drain plugs on each side of the block. All EFI engines have a knock sensor located in one of the drain holes. This unit must be re-installed in the drain hole. **Carefully install this unit without using any additional thread sealant. Be careful to avoid overtightening this unit. Torque specification for installation of the knock sensor is 14-16-ft.-lbs.**

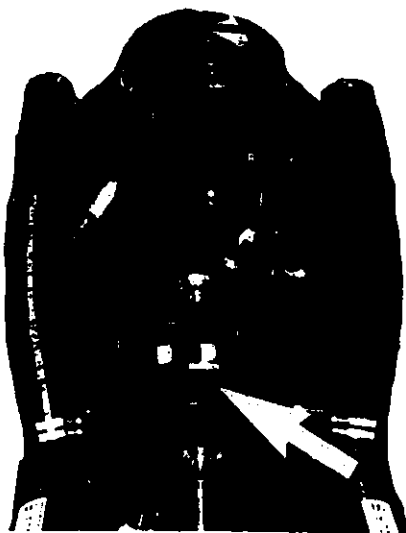

**STEP 3 AREA ILLUSTRATED.**

..... Check the propeller shaft coupling alignment. Install and tighten the coupling hardware.

..... Check the engine compartment and bilge for signs of nesting animals. Clean as necessary.

7..... Check the entire engine for cracks or leaks caused by freeze damage.

8..... Check all hose clamps for tightness. Install the bilge drain plug.

9..... Grease the propeller shaft taper and install the propeller.

10..... Perform the daily maintenance. If not performed during storage, perform the annual maintenance.

11..... If the boat is equipped with the optional fresh-water cooling system and was drained for storage, fill the system with fresh coolant solution.

12..... Turn the fuel line ON-OFF valve to the ON position in models that do not have in-tank fuel pumps. With the boat in the water, cycle the key ON and then OFF 2-3 times, allowing 10 seconds between key cycles, before cranking the engine. This allows the fuel pump to prime the fuel lines; then start the engine. In the event the engine does not respond, allow a two-minute cool-down period for every 30 seconds of cranking. When the engine fires, keep a close watch over the gauge readings and check for leakage and abnormal noises. **Keep speeds low for the first 15 minutes to allow the engine to reach normal operating temperature.**

# Troubleshooting

**T**HE FOLLOWING CHARTS WILL ASSIST YOU IN FINDING AND CORRECTING MINOR mechanical and electrical problems with your boat. Problems are listed in the the order of the most-likely event to the least-likely.

To correct a problem, first determine what the problem is. Start with the first cause and eliminate the possibility of each until the problem is corrected. Because of the specialized skill and tools needed to correct major issues, we have not included that information. If you suspect a problem not addressed here, please contact your MasterCraft dealer.

PROBLEM	POSSIBLE CAUSE	SOLUTION
Engine will not turn over.	<ul style="list-style-type: none"> <li>■ Safety switch tether not connected.</li> <li>■ Throttle/shifft control in gear.</li> <li>■ Main circuit breaker open.</li> <li>■ Battery terminals corroded.</li> <li>■ Battery weak or worn out.</li> <li>■ Loose or corroded battery wiring connections.</li> <li>■ Defective starter solenoid.</li> <li>■ Defective neutral safety switch.</li> <li>■ Defective starter motor.</li> <li>■ Defective ignition switch or wiring.</li> <li>■ Water in the engine.</li> </ul>	<ul style="list-style-type: none"> <li>■ Connect the safety switch tether.</li> <li>■ Shift to neutral.</li> <li>■ Re-set the circuit breaker.</li> <li>■ Clean the battery terminals.</li> <li>■ Charge or replace the battery.</li> <li>■ Clean and tighten the battery wiring connections.</li> <li>■ Replace starter solenoid.</li> <li>■ Replace the neutral safety switch.</li> <li>■ Replace the starter motor.</li> <li>■ Replace the ignition switch or repair the wiring.</li> <li>■ Remove the spark plugs and look for water or gas in the cylinders. See your dealer.</li> </ul>

PROBLEM	POSSIBLE CAUSE	SOLUTION
Engine turns over, but will not start.	<ul style="list-style-type: none"> <li>■ Safety switch tether not connected.</li> <li>■ No fuel to the engine.</li> <li>■ No fuel in the tank.</li> <li>■ Fuel filter clogged.</li> <li>■ Contaminated fuel.</li> <li>■ Weak or shorted ignition coil.</li> <li>■ Distributor problems.</li> </ul>	<ul style="list-style-type: none"> <li>■ Connect the safety switch tether.</li> <li>■ Turn the fuel valve to ON position.</li> <li>■ Fill the fuel tank.</li> <li>■ Replace fuel filter.</li> <li>■ Replace fuel and filter.</li> <li>■ Replace the ignition coil.</li> <li>■ See your dealer.</li> </ul>
Engine is hard to start.	<ul style="list-style-type: none"> <li>■ Flooded engine.</li> <li>■ Plugged flame arrestor.</li> <li>■ Fouled spark plugs.</li> <li>■ Loose coil or ignition wires.</li> <li>■ Battery cables loose or corroded.</li> <li>■ Weak battery.</li> <li>■ Ignition problems.</li> </ul>	<ul style="list-style-type: none"> <li>■ Start the engine at full throttle and back off immediately.</li> <li>■ Clean the flame arrestor.</li> <li>■ Replace the spark plugs.</li> <li>■ Tighten coil or ignition wires.</li> <li>■ Clean and tighten the battery cables.</li> <li>■ Charge or replace the battery.</li> <li>■ See your dealer.</li> </ul>
Engine misses or idles rough.	<ul style="list-style-type: none"> <li>■ Fouled spark plugs.</li> <li>■ Loose or defective high-tension leads.</li> <li>■ Plugged PCV valve.</li> <li>■ Weak ignition coil.</li> <li>■ Vacuum leak.</li> </ul>	<ul style="list-style-type: none"> <li>■ Replace the spark plugs.</li> <li>■ Tighten or replace the high-tension leads.</li> <li>■ Replace the PCV valve.</li> <li>■ Replace the ignition coil.</li> <li>■ See your dealer.</li> </ul>
Poor boat performance.	<ul style="list-style-type: none"> <li>■ Fouled spark plugs.</li> <li>■ Contaminated fuel.</li> <li>■ Plugged flame arrestor.</li> <li>■ Weak ignition coil.</li> <li>■ Fuel filter clogged.</li> <li>■ Ignition problems.</li> </ul>	<ul style="list-style-type: none"> <li>■ Replace the spark plugs.</li> <li>■ Replace the fuel and filter.</li> <li>■ Clean the flame arrestor.</li> <li>■ Replace the ignition coil.</li> <li>■ Replace the fuel filter.</li> <li>■ See your dealer.</li> </ul>

PROBLEM	POSSIBLE CAUSE	SOLUTION
Poor gas mileage.	<ul style="list-style-type: none"> <li>■ Fouled spark plugs.</li> <li>■ Plugged flame arrestor.</li> <li>■ Inefficient driving habits.</li> <li>■ Plugged PCV valve.</li> <li>■ Ignition problems.</li> </ul>	<ul style="list-style-type: none"> <li>■ Replace the spark plugs.</li> <li>■ Clean the flame arrestor.</li> <li>■ Plane the boat quickly, then slow down to desired speed.</li> <li>■ Replace the PCV valve.</li> <li>■ See your dealer.</li> </ul>
Throttle/shifting problems.	<ul style="list-style-type: none"> <li>■ Corroded cables.</li> <li>■ Defective throttle return spring.</li> <li>■ Low transmission oil level.</li> <li>■ Sticking transmission shift detent ball.</li> <li>■ Kink in cable(s).</li> </ul>	<ul style="list-style-type: none"> <li>■ Clean and lubricate the cables.</li> <li>■ Replace the throttle return spring.</li> <li>■ Replenish transmission fluid.</li> <li>■ Clean and lubricate detent ball.</li> <li>■ Replace the cable(s). See your dealer.</li> </ul>
Steering problems.	<ul style="list-style-type: none"> <li>■ Corroded cable.</li> <li>■ Rudder worn.</li> </ul>	<ul style="list-style-type: none"> <li>■ Clean and lubricate the cable.</li> <li>■ See your dealer.</li> </ul>
Excessive vibration.	<ul style="list-style-type: none"> <li>■ Bent strut.</li> <li>■ Fouled propeller.</li> <li>■ Damaged propeller.</li> <li>■ Misaligned propeller shaft coupling.</li> <li>■ Bent propeller shaft.</li> </ul>	<ul style="list-style-type: none"> <li>■ Replace strut.</li> <li>■ Remove objects from the propeller shaft and rudder.</li> <li>■ Replace the propeller.</li> <li>■ Check the alignment. See your dealer for proper realignment.</li> <li>■ See your dealer.</li> </ul>
Electrical problems.	<ul style="list-style-type: none"> <li>■ Open circuit breaker or blown fuse.</li> <li>■ Loose wiring connections or corrosion.</li> <li>■ Defective sending unit.</li> <li>■ Shorted wiring harness.</li> <li>■ Defective switch or gauge.</li> </ul>	<ul style="list-style-type: none"> <li>■ Reset the circuit breaker or replace the fuse.</li> <li>■ Clean and tighten wiring connections.</li> <li>■ Replace the sending unit.</li> <li>■ Repair the wiring harness. See your dealer.</li> <li>■ See your dealer.</li> </ul>

PROBLEM	POSSIBLE CAUSE	SOLUTION
No speedometer reading.	<ul style="list-style-type: none"> <li>■ Disconnected, kinked or plugged tubing.</li> <li>■ Plugged pitot pick-up.</li> <li>■ Defective pitot pick-up.</li> <li>■ Defective speedometer.</li> </ul>	<ul style="list-style-type: none"> <li>■ Repair or replace the tubing.</li> <li>■ Remove objects from pitot pick-up.</li> <li>■ Replace pitot pick-up.</li> <li>■ Replace the speedometer.</li> </ul>
Incorrect speedometer reading.	<ul style="list-style-type: none"> <li>■ Blocked pitot gauge.</li> <li>■ Water in the tubing.</li> <li>■ Improper calibration.</li> <li>■ Defective speedometer.</li> </ul>	<ul style="list-style-type: none"> <li>■ Remove the blockage.</li> <li>■ Disconnect the tubing at the speedometer and blow out the tubing. Tighten nut finger snug, then 1/4-turn more.</li> <li>■ Recalibrate the speedometer.</li> <li>■ Replace the speedometer.</li> </ul>
Gauges are not working or accessory does not work.	<ul style="list-style-type: none"> <li>■ Breaker has tripped.</li> <li>■ Fuse has blown.</li> </ul>	<ul style="list-style-type: none"> <li>■ Re-set breaker.</li> <li>■ Replace fuse.</li> </ul>



# Specifications

## Engine

MasterCraft Vortec MX Predator  
Marine Electronic Fuel Injection

Displacement . . . **350 C.I.D. (5.7 Liters)—310 horsepower**  
 Bore . . . . . **4.00"**  
 Stroke . . . . . **3.48"**  
 Compression Ratio . . . . . **9.4:1**  
 Compression Pressure . . . . . **180-200 psi**  
 Maximum Allowable Compression Variation . . . . .  
 . . . . . **Highest to lowest within 75%**  
 Maximum Allowable RPM at WOT . . . . . **4200-5000 RPM**  
 Oil Pressure (Hot) . . . . . **40 PSI at 2000 RPM**  
 Propshaft Rotation . . . . . **LH**  
 Fuel Requirement . . . . . **.89 Octane**  
 Fuel Pressure: Operating Pressure . . . . . **20-30 PSI**  
 Fuel Pump Volume . . . . . **.1 pint in 20 seconds**  
 Type of Fuel Induction . . **Marine Electronic Fuel Injection**  
 . . . . . **Throttle Body Type**  
 Electrical System . . . . . **12 Volt**  
 Ignition Type . . . . . **Distributor HEI**  
 Electronic Control Module . **Delco Electronics Waterproof**  
**Marine Controller (MEFI 3/CEFI 3)**  
 Alternator Output Rating . . . . . **51 amps at 2200 RPM**  
 Thermostat . . . . . **160 degrees**  
 Spark Plug Type . . . . . **AC MR43LTS**  
 Recommended Plug Gap . . . . . **.045"**  
 Firing Order . . . . . **1-8-4-3-6-5-7-2**  
 Recommended Battery Rating . . . . .  
 . . . . . **525 cold cranking amps for 30 sec**  
**at 0 degrees Fahrenheit**  
 Oil Capacity . . . . . **4-5 quarts with filter change—**  
**verify with dipstick**  
 Oil Type . . . . . **SAE 15W-40, CG-4SJ**  
 Oil Filter Type . . . . . **PF25 or PZ3**  
 Transmission Fluid Capacity . . . . .  
 . . . . . **1-1/2 to 2 qts with 1:1 transmission**  
**2-1/2 to 3 qts with 1.5:1 transmission**  
 Initial Timing . . . . . **10 degrees BTDC at 1000 fixed RPM**  
 Total Ignition Advance . . . . .

. . . . . **Varies as a function of input information**  
 Cylinder Numbering Front to Rear . . . . . **Left bank 1-3-5-7**  
**Right bank 2-4-6-8**

## Engine

MasterCraft Vortec MX Max LTR  
Marine Electronic Fuel Injection

Displacement . . . **350 C.I.D. (5.7 Liters)—330 horsepower**  
 Bore . . . . . **4.00"**  
 Stroke . . . . . **3.48"**  
 Compression Ratio . . . . . **9.4:1**  
 Compression Pressure . . . . . **180-220 psi**  
 Maximum Allowable Compression Variation . . . . .  
 . . . . . **Highest to lowest within 75%**  
 Maximum Allowable RPM at WOT . . . . . **4800-5200 RPM**  
 Oil Pressure (Hot) . . . . . **40 PSI at 2000 RPM**  
 Propshaft Rotation . . . . . **LH**  
 Fuel Requirement . . . . . **.89 Octane minimum**  
 Fuel Pressure: Operating Pressure . . . . . **35-45 PSI**  
 Fuel Pump Volume . . . . . **.1 pint in 20 seconds**  
 Type of Fuel Induction . . **Marine Electronic Fuel Injection**  
**Direct Port Type**  
 Electrical System . . . . . **12 Volt**  
 Ignition Type . . . . . **Northstar LSI multi-coil**  
 Electronic Control Module . **Delco Electronics Waterproof**  
**Marine Controller (MEFI 3/CEFI 3)**  
 Alternator Output Rating . . . . . **51 amps at 2200 RPM**  
 Thermostat . . . . . **160 degrees**  
 Spark Plug Type . . . . . **AC MR43LTST**  
 Recommended Plug Gap . . . . . **.045"**  
 Firing Order . . . . . **1-8-4-3-6-5-7-2**  
 Recommended Battery Rating . . . . .  
 . . . . . **525 cold cranking amps for 30 sec**  
**at 0 degrees Fahrenheit**  
 Oil Capacity . . . . . **4-5 quarts with filter change—**  
**verify with dipstick**  
 Oil Type . . . . . **SAE 15W-40, CG-4SJ**

Oil Filter Type ..... **PF25 or PZ3**  
 Transmission Fluid Capacity .....  
     ..... **1-1/2 to 2 qts with 1:1 transmission**  
     ..... **2-1/2 to 3 qts with 1.5:1 transmission**  
 Initial Timing ..... **10 degrees BTDC at 1000 RPM fixed**  
     ..... **Factory set—Not field adjustable**  
 Total Ignition Advance .....  
     ..... **Varies as a function of input information**  
 Cylinder Numbering Front to Rear ..... **Left bank 1-3-5-7**  
     ..... **Right bank 2-4-6-8**

Recommended Plug Gap ..... **0.050"**  
 Firing Order ..... **1-2-7-3-4-5-6-8**  
 Recommended Battery Rating .....  
     ..... **.525 cold cranking amps for 30 sec**  
     ..... **at 0 degrees Fahrenheit**  
 Oil Capacity ..... **7.5 quarts with filter change**  
     ..... **(8.5 w/cooler)—verify with dipstick**  
 Oil Type ..... **SAE 15W-40, CG-4SJ**  
 Oil Filter Type ..... **PF 58**  
 Transmission Fluid Capacity .....  
     ..... **2-1/2 to 3 qts with 1.5:1 transmission**  
     ..... **or V-drive transmission**  
 Initial Timing ..... **Factory-set and computer-controlled—**  
     ..... **Not field adjustable**

## Engine

MasterCraft Power/Cadillac Northstar 4 6L  
 Marine Electronic Fuel Injection

Displacement ... **279 C.I.D. (4.6 Liters)—320 horsepower**  
     ..... **at 6000 RPM**  
 Torque ..... **318 lb-ft @ 4500 RPM**  
 Bore ..... **3.66"/93 mm**  
 Stroke ..... **3.31"/84 mm**  
 Camshafts ..... **DOHC (4 valves/cyl)**  
 Intake Valves ..... **.16 (1.30"/33 mm)**  
 Exhaust Valves ..... **.16 (1.14"/29 mm)**  
 Valve Lifters ..... **Direct Acting Hydraulic**  
 Cylinder Head Material ..... **Aluminum (Die Cast)**  
 Block Material ... **Aluminum (Die Cast) w/cast iron liners**  
 Combustion Chamber Volume ..... **.51.8 cc**  
 Compression Ratio ..... **10.3:1**  
 Compression Pressure ..... **140-170 psi**  
 Maximum Allowable Compression Variation .....  
     ..... **Highest to lowest within 75%**  
 Maximum Allowable RPM at WOT ..... **5800-6200 RPM**  
 Oil Pressure (Hot) ..... **.35 PSI at 2000 RPM**  
 Fuel Requirement ... **92 Octane (R+M)/2 (RFG acceptable)**  
 Fuel Pressure: Operating Pressure ..... **43-53 PSI**  
 Fuel Pump Volume ..... **1 pint in 20 seconds**  
 Type of Fuel Induction ... **Marine Electronic Fuel Injection**  
     ..... **Phased Port Type**  
 Electronic Control Module ... **Delco Electronics Waterproof**  
     ..... **Marine Controller (MEFI 3/CEFI 3)**  
 Ignition System ..... **Northstar Multi-Coil LSI**  
 Alternator Output Rating ..... **.51 amps at 2200 RPM**  
 Thermostat ..... **.160 degrees**  
 Spark Plug Type ..... **AC 41-950**

Total Ignition Advance .....  
     ..... **Varies as a function of input information**  
 Cooling System—Engine ... **Full Fresh Water (closed) 12 qt.**  
     ..... **50/50 Propylene Glycol & Water**  
 Cooling System—Engine Oil/Transmission .....  
     ..... **Raw Water—Full Flow Tandem**  
 Pump Capacity—Raw ..... **.25 GPM**  
 Pump Capacity—Circulating ..... **.104 GPM**  
 Propshaft Rotation ..... **LH**  
 Cylinder Numbering Front to Rear ..... **Left bank 2-4-6-8**  
     ..... **Right bank 1-3-5-7**

## Propellers

### ProStar 190

MX Plus w/Hurth 1:1 ..... **4-blade 13"x13" heavy-cup**  
 MX Plus w/Hurth 1.5:1 ..... **4-blade 14"x20" heavy-cup**  
 MX Max LTR w/Hurth 1:1 ..... **4-blade 13"x13" light-cup**  
 MX Max LTR w/Hurth 1.5:1 ... **4-blade 14"x18" light-cup**

### ProStar 205

MX Plus w/Hurth 1:1 ..... **4-blade 13"x13" heavy-cup**  
 MX Plus w/Hurth 1.5:1 ..... **4-blade 14"x20" heavy-cup**  
 MX Max LTR w/Hurth 1:1 ..... **4-blade 13"x13" light-cup**  
 MX Max LTR w/Hurth 1.5:1 ... **4-blade 14"x20" light-cup**

### ProStar 205 V-Drive

MX Plus w/Hurth 1.46:1 ..... **4-blade 14"x20" heavy-cup**  
 MX Max LTR w/Hurth 1.46:1 ... **4-blade 14"x20" light-cup**

### SportStar 19

MX Plus w/Hurth 1:1 ..... **3-blade 13"x13"**

# Optional Equipment

## **Power Slot Package**

**T**HE POWER SLOT PACKAGE IS BASED UPON A 1.5:1 TRANSMISSION RATIO FOR greater pulling power.

## **Fresh Water Cooling System**

**T**HE FRESH-WATER COOLING SYSTEM IS SELF-CONTAINED AND CONSISTS OF A water-to-water heat exchanger, reservoir and interconnecting hoses. Water supplied by the raw water system removes heat from the engine coolant in the heat exchanger. The engine water pump circulates coolant throughout the system.

Although clean water alone could be used in this system, we recommend that a 50/50 solution of soft, clean water and automotive anti-freeze be used to prevent corrosion. The only additional maintenance considerations are an annual check of anti-freeze protection under the guidelines indicated elsewhere to prevent corrosion and the addition of water pump lubricant according to manufacturer's instructions.

## **Boat and Cockpit Cover**

**A** BOAT COVER IS A MUST FOR ALL BOATS. PROTECTION FROM RAIN, BIRDS AND THE damaging effects of ultraviolet light will help keep the boat looking new for years. Keep the cover on during all periods of non-use, except when trailering.

## **Heater**

**T**HE SELF-CONTAINED AUTOMOTIVE TYPE HEATER HAS TWO ADJUSTABLE VENTS, for the operator and for the observer. To use the heater, before starting the engine open the engine box and locate the heater valve on the engine intake manifold. Open the valve fully.

After the engine has started, turn the accessory switch ON for heat. Close the heater valve fully when not using the heater.

The heater is maintenance-free, except for the removal of any water from the core and hoses during winter storage.

## **Additional Options**

- Tonneau Cover
- Sun Top
- Bimini Top
- Safe-T-Top with removable brackets  
(ProStar 190 & SportStar 19 closed bow models only)
- Safe-T-Top cover (ProStar 190 & SportStar 19 closed bow models only)
- Pressurized Shower
- Tournament KPH speedometers
- Boat house cradle
- Depth finder
- Removable customized swim platform
- Wakeboard kits
- Trailer guide post covers
- Sportswear and accessories

*Note: Not all optional equipment items listed here are available on all models. Additional items may be available. Check the sales brochure for more information.*

**NOTE: If the boat is equipped with both a heater and fresh water cooling—and, if adequate anti-freeze protection is used—the heater does not have to be emptied of coolant during the winter storage period.**

# Dealer Service and Warranty

## Dealer Service

**Y**OUR MASTERCRAFT DEALER HAS BEEN CAREFULLY CHOSEN TO PROVIDE YOU with expert service when needed. Our dealers are equipped with the latest service information and training for competent and courteous routine maintenance and service. They will also be glad to assist you with *do-it-yourself* replacement parts and advice.

For your safety, when replacing any parts on your MasterCraft, be sure to request the use of genuine MasterCraft replacement parts or parts approved by USCG and ABYC. **Never use automotive replacement parts for marine applications. In many instances, automotive parts are not designed to offer you the safety and commercial durability needed for marine use.**

## Warranty Service

**A**LTHOUGH MASTERCRAFT BOATS ARE EXTREMELY RELIABLE, A PROBLEM MAY develop on occasion. If the boat is still under warranty, you may bring it to any one of the over 120 dealers in our network. If you have questions regarding warranty coverage, ask your dealer or contact the factory directly by writing to:

**Warranty Department  
MasterCraft Boat Company  
100 Cherokee Cove Drive  
Vonore TN 37885**

## Warranty Registration

**A**T THE TIME OF PURCHASE OF YOUR MASTERCRAFT, YOU AND YOUR DEALER must fill out all portions of the warranty registration and new boat check-list card. It is extremely important that the registration information card be filled-in at the time of the sale and be mailed by your dealer to the address shown on the card *within 14 days* of purchase.

Delays in mailing could result in delays in any service work pre-approvals, as well as implementing our formal processing of your records for surveys, recalls and other MasterCraft consumer publications. The information on the card is not only used to validate the warranty—enabling you to receive service—but also allows MasterCraft to comply with the *Federal Boating Safety Act*, which will ensure your notification should a recall campaign be started. This information will also aid law enforcement officials and insurance companies in recovery of stolen boats. Original purchasers should inform MasterCraft of any change of address for this same reason.

We will also be able to keep you informed of *Team MasterCraft* news, new accessories and service items that may become available to you.

## **Warranty Claims**

**T**O MAKE A CLAIM UNDER WARRANTY, CONTACT THE MASTERCRAFT DEALER from whom your boat was originally purchased, or the nearest dealer, and he will gladly assist you. It is highly recommended that warranty service on your MasterCraft be performed by the original dealer because of their personal interest in you.

**Remember: your MasterCraft must be delivered to a dealer within 10 days of discovery of the defect in order for it to be covered by warranty.**

Proof of purchase, such as a copy of your warranty card registration, may be required by the dealer to substantiate any warranty claim.

During the period of warranty, any authorized MasterCraft dealer will—free of charge—repair or replace, at MasterCraft's option, any item manufactured by MasterCraft Boat Company that proves to be defective (upon examination by MasterCraft) due to faulty workmanship or material from the factory. All replaced parts will become the property of MasterCraft Boat Company.

**U**NDER THE TERMS OF THIS WARRANTY, THE OWNER IS RESPONSIBLE FOR ENSURING that the boat is registered for warranty, properly operated, maintained and stored in accordance with the owner's manual.

**A**S THE OWNER OF A BOAT, YOU HAVE CERTAIN RESPONSIBILITIES THAT MUST BE acknowledged before taking to the water for the first time. In many cases, your MasterCraft dealer will be able to help you meet these responsibilities.

**A**LL POWER BOATS OPERATED ON FEDERALLY CONTROLLED NAVIGABLE WATERS OF the United States must be registered and numbered in the state of principal use. Contact your state boating authorities to request a Certificate of Number application.

**I**NSURANCE FOR YOUR MASTERCRAFT SHOULD BE OBTAINED AS SOON AS PRACTICAL for protection against loss by fire, theft, and damage covered by a policy. Also, additional liability protection is recommended. Consult your insurance agent or ask your MasterCraft dealer for a referral.

## **Owner's Warranty Responsibilities**

## **Owner's Boating Responsibilities**

## **Registration**

## **Insurance**

## Periodic Maintenance

**M**AINAINING YOUR BOAT IN GOOD WORKING ORDER IS A CONDITION OF warranty, as well as an important safety habit. It will add to the resale value. Implement a routine for periodic maintenance, including daily checks. Consult your MasterCraft dealer.

## Briefing Passengers

**O**N EVERY OUTING, MAKE SURE THAT AT LEAST ONE PASSENGER IS FAMILIAR with the operation and safety aspects of the boat, in case of emergency. Show all passengers the location of emergency equipment and how to use it.

## Courtesy

**F**OR THE MOST PART, BOATERS ARE A FRIENDLY AND COURTEOUS GROUP. KNOW THE rules of the road and learn the peculiar patterns of any body of water. Give fishermen and sailors plenty of room. Look for personal water vehicles. Keep speeds down in congested and restricted areas.

Always check with local authorities for specific local laws before operating on area waterways.

You are responsible for spotting and avoiding swimmers and slow-moving vessels. You are also responsible for any damage caused by your wake. Don't throw refuse overboard or discharge liquids such as oil.

Help to keep boating fun for everyone! Ask your local Coast Guard Auxiliary or state boating authorities for more information on boating courses and safety instruction.

## Storage

**P**ROPER STORAGE OF YOUR BOAT AND TRAILER DURING THE OFF-SEASON WILL make re-activating a lot easier. A few hours of preparation can save both time and money the following spring. Consult your MasterCraft dealer for storage supplies or services.

# The MasterCraft Limited Warranty

---

**M**asterCraft WARRANTS TO THE ORIGINAL RETAIL PURCHASER THAT EACH NEW BOAT IS FREE FROM STRUCTURAL defects in material and workmanship under normal use and when operated and maintained according to the operator's instructions, for a period from:

- I. DATE OF PURCHASE OF THE DECK, HULL, LINER AND STRINGERS FOR AS LONG AS THE ORIGINAL RETAIL PURCHASER owns the boat.

**In addition to the Limited Warranty, MasterCraft offers a Transferable Five-Year Limited Warranty covering the deck, hull and stringer system. This policy may be transferred (for a nominal fee) to subsequent purchasers during a period of five (5) years from the date of delivery to the original retail purchaser.**

**Any warranty coverage remaining during the time specified in paragraphs II and III will automatically transfer to any subsequent owner(s) who pays the warranty fee.**

**Exception: This five (5) year warranty does not cover the gelcoat or any other components fastened or applied to the hull or deck. Gelcoat discoloration, blisters or bubbles and cracks are not considered structural defects.**

- II. ONE (1) YEAR ON COMPONENT PARTS MANUFACTURED BY MasterCraft.

- III. THREE (3) YEARS ON THE ENGINE/TRANSMISSION.

**S**UBJECT TO THE TERMS OF THE LIMITED WARRANTY, ANY COVERED BOAT OR PART WITH STRUCTURAL DEFECTS IN MATERIAL or workmanship that is returned to MasterCraft's authorized repair facility or factory during the above stated warranty periods will, at MasterCraft's option, be repaired or replaced without charge to the owner. The terms of this Limited Warranty are as follow:

- I. MasterCraft shall repair or replace at its option, any item that proves defective upon examination by MasterCraft's authorized personnel.
- II. MasterCraft warrants said repairs or replacements for the remainder of the warranty period.
- III. MasterCraft shall fulfill its obligation to repair or replace the defective item at its factory or authorized repair facility.



IV. MasterCraft's obligation under this warranty shall be limited to the repair or replacement of any item judged defective by MasterCraft.

V. The owner shall be responsible for transportation of the boat or part(s) to the authorized MasterCraft facility and for any return transportation cost of said item.

**M**asterCraft BOATS ARE MANUFACTURED BY TRAINED CRAFTSMEN FROM HIGH-QUALITY MATERIALS AND COMPONENTS. However, conditions outside MasterCraft's control require specific exclusions from coverage under this warranty. The MasterCraft Warranty *does not include* the following:

- I. Any damage or repair required because of misuse, negligence, accident, collision or impact with any object; or any improper alteration or repair.
- II. Any boat used for speed, commercial competition or performance demonstration.
- III. Any boat which is: (a) used for rental or other commercial or industrial purposes; (b) used in boat racing, demonstrations or similar events; (c) altered, modified, repaired or replaced so as to increase the cubic-inch capacity or horsepower output of the engine and boat as originally manufactured.
- IV. All component parts and accessories not manufactured by MasterCraft, including but not limited to: engines, drivetrains, transmissions, propellers, shift and throttle control levers and cables, pumps, blowers, windshields, canvas, upholstery, instrumentation and steering systems. However, where any such items are warranted by a component or accessory manufacturer, MasterCraft will, if possible, furnish the manufacturer's warranty document to the owner.
- V. Limited Warranty on the deck, hull and liner covers only the named items and does not include hardware and other components fastened or adhered to the hull, deck or liner.
- VI. Paints, varnishes, gelcoat surfaces and colors, finish distortions, chrome-plated or anodized finishes, floor and floor covers and any other surface coatings. **IMPORTANT:** MasterCraft has been made aware that an increasing number of owners are leaving their boats in the water for long periods of time. Although MasterCraft uses the highest-grade NPG gelcoat materials, a condition may develop where the bottom may show signs of discoloration and/or blisters. Should this condition occur, it will not be covered by warranty from MasterCraft or its suppliers. It is suggested that for boats required to stay in the water for long periods, a good bottom paint should be applied for additional protection.
- VII. Liability for special or consequential damages, such as, but not limited to consequential relating to, for third party claims against the purchaser, or damages for loss of profit. Any implied warranty of merchantability, fitness for a particular purpose, or otherwise, are limited to the duration of the applicable express warranty.
- VIII. "Note: To the extent any provision of this warranty is prohibited by federal, state or local law and cannot be pre-empted, it shall not be applicable. This warranty gives you specific legal rights and you may also have other rights which vary from state to state."

MasterCraft Boat Company, Inc., 100 Cherokee Cove Drive, Vonore TN 37885

# MasterCraft Trailers

## .....Trailer and Launching

**Q**uick Tips for maintaining your trailer in tip-top condition:

- ✓ Chips in the paint, especially on the axles and frame result when these surfaces are subjected to repeated or severe hits by external objects. Usually, this is gravel or asphalt chips thrown up by the rear tires of the tow vehicle. Over time, rust may develop where paint has been chipped away and this is not covered by the trailer's warranty. To avoid this, consider attached mud flaps behind the tow vehicle's rear tires.
- ✓ To ensure proper operation of the trailer jack, it should be wiped down and lubricated on a regular basis.
- ✓ If the trailer is backed into salt water, you must completely and thoroughly wash the trailer to ensure that it will not eventually rust. Salt water is very corrosive, even on galvanized trailers and can corrode the brake system as well. Exposure to salt water can also cause brake pads to stick and function improperly.
- ✓ Check the braking system annually, along with the wheel bearings. If you find anything that appears to be worn, take the trailer to your MasterCraft dealer for a check and possible repair.
- ✓ Always approach the trailer slowly as you prepare to load your boat. This will allow you to retain greater control. Hard impact with the trailer or improper alignment on the trailer can result in damage to the boat, the trailer or both, and this is not covered under warranty. Also, if your trailer is equipped with the Boat Buddy System, a hard hit against it could cause damage, which is also not covered by warranty.
- ✓ Disc brakes on the trailer requires an additional wire hook-up for the trailer lights. This wire is blue and hooks up to the back-up light wire circuit on the tow vehicle. It's very important to attach this properly so that the brakes will disengage when you are backing up.

# Trailer/Launching

**W**ITH THE PURCHASE OF YOUR NEW, CUSTOM-BUILT MasterCraft TRAILER YOU have added value to your MasterCraft boating enjoyment. You can now enjoy almost any of the thousands of recreational waterways in the country.

As the manufacturer, MasterCraft has provided you with a vehicle designed specifically for many years of attractive, convenient, trouble-free service. Now, it is up to you to give it proper care and maintenance to be sure it will continue to perform safely and satisfactorily.

The purpose of this section of the owners manual is to help you do just that. Please read and follow its warnings and instructions carefully. Also, because all trailers are not exactly alike, be sure to read and comply with any warnings and additional information supplied by MasterCraft in your owners packet about your specific model. It's the best way to obtain peak performance.



## WARNING

Before leaving the trailer, be sure to read and familiarize yourself with the section of your owner's manual.

## Trailer/Launching Check List

**N**EVER TOW THIS TRAILER BEFORE YOU CHECK TO BE SURE:

- Coupler, hitch and hitch ball are of the same size.
- Coupler and safety cables are safely secured to the hitch.
- Check all fasteners for proper tightness.
- The boat is securely anchored to the trailer. (The winch strap is not a satisfactory tie-down.)
- The wheel lug nuts are properly tightened.
- The wheel bearings are properly adjusted and maintained.
- The load is within the maximum load-carrying capacity of both the trailer and of the tow vehicle.
- The tires are properly inflated.
- All trailer lighting is working properly.
- Trailer brakes are properly adjusted and working, if the trailer is so equipped.

This trailer is manufactured to meet the applicable federal safety standards. Check the local and state requirements regarding any additional equipment that may be required.

**NOTE: Trailer laws covering such things as brakes, lights, safety cables, licenses, etc., will vary from state to state. Be sure that your trailer is in full compliance with applicable state laws. Your MasterCraft dealer can help you in this regard. Otherwise, contact your nearest state motor vehicle department.**

**T**HE KEY TO CAREFREE BOAT TRAILERING IS THE PROPER MATCH OF BOAT TO trailer. This proper match is only one reason why the MasterCraft Engineering Department has designed your trailer to carry the full weight of your boat, engine and gear. It also provides the proper support for the boat hull.

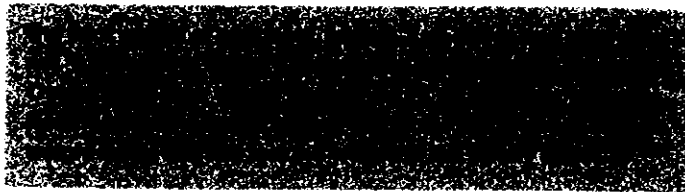

### *A Proper Match*



**WARNING**

### *Load-Carrying Capacity*

**C**HECK THE METALLIC CERTIFICATION LABEL ATTACHED TO THE LEFT, FORWARD side of your trailer. It will show the maximum load-carrying capacity of the trailer. It will also show the Gross Vehicle Weight Carrying Rating (GVWR), which is the load-carrying capacity plus the weight of the trailer itself. Be sure that the total weight of your boat engine, gear and trailer do not exceed the GVWR.

If you don't know the correct weight of your boat once it's loaded with gear, don't guess. Have it weighed. This usually can be done at a local lumber yard, feed and fertilizer store or truck weight station.

Be especially careful to avoid overloading your trailer by putting in heavy baggage, camping gear, etc., inside the boat.

Don't tow the boat with a water-filled bladder for wakeboarding. Empty the contents or the tongue weight will be incorrect.

**I**MPROPER WEIGHT DISTRIBUTION CAN CAUSE A BOAT TRAILER TO FISH-TAIL (SWAY from side-to-side) as it moves down the highway, putting excessive strains on both trailer and towing equipment, increasing gas consumption and sometimes causing an accident. The most effective way to guard against fish-tailing is to make sure the weight load on your trailer is properly distributed.

### *Weight Distribution*

It is extremely important that 5-to-10-percent of the total weight of your loaded trailer should be felt at the trailer coupling ball when the tongue is parallel to the ground. A bathroom scale can be used for this determination.

For example, if the gross weight of the trailer, boat and gear is 3,000 pounds, the weight on the tongue should not be more than 300 pounds, but not less than 150 pounds. (Some auto manufacturers say that tongue weight should not exceed 200 pounds when using a weight-carrying bumper-mounted hitch with full-sized cars.)

The importance of an adequate download on the hitch ball cannot be over-emphasized.



## WARNING

### Trailer Hitch

**T**HERE ARE TWO BASIC TYPES OF TRAILER HITCHES: A WEIGHT-CARRYING HITCH and a weight-distributing hitch. A weight-carrying hitch is recommended for your MasterCraft. Before deciding which type of hitch to use, consult your automobile manufacturer on recommendations for your car or truck.

Be sure that the total weight of your trailer-boat rig does not exceed the hitch's load capacity. The maximum weight it can handle is stamped on the hitch. *ALSO, BE SURE THE HITCH BALL IS THE CORRECT SIZE TO MATCH THE COUPLER ON YOUR TRAILER.* The correct ball diameter is marked on the trailer coupler. The hitch also should provide a place for attaching the trailer's safety cables—two rings or holes on either side of the hitch ball.

A truck or van using a step bumper as the hitch platform will need to have safety cable attachments such as eye-bolts, as well as a hitch ball, installed according to the Society of Automotive Engineers SAE J684 Standard. Installing a light or heavy-duty hitch can be a major undertaking. The hitch and its installation should meet the SAE J684 Standard. It is recommended that you have the job done by a professional. Your dealer can advise you.

To insure that the boat is riding properly on the trailer supports, the trailer should be in a level position when hitched to the tow vehicle. The recommended height of the hitch ball, according to the NMMA, is 16-18-inches to the top of the ball from the ground. More importantly, if the coupler is much lower than the rear end of the trailer, it may prematurely activate the surge brakes. This can be corrected in a number of different ways. For example, you may install air-pressure adjustable shock absorbers on the tow vehicle, or switch from a weight-carrying hitch to a weight-distributing hitch. Again, consult your tow vehicle dealer.



Series injury or property damage can result if the load weight on your hitched trailer exceeds the capacity of the hitch on your tow vehicle.

**T**HE SAFETY CABLES ON YOUR MasterCraft TRAILER PROVIDE ADDED INSURANCE that it will not become detached from the towing vehicle when underway. Before each trip, you should make sure that the proper cables are correctly attached between the towing vehicle and the trailer.

As noted above, your trailer hitch should provide a place for attaching safety cables, holes or rings on both sides of the hitch ball. It is strongly recommended—and in fact, most states require it—that you crisscross the cables under the trailer tongue. The cables on the left side of the trailer tongue should be attached to the hole or ring on the right side of the hitch ball, and the right cable should be attached to the hole or ring on the left side of the hitch ball. This will prevent the trailer tongue from dropping to the road if the trailer coupler separates from the hitch ball.

The cables should be rigged as tight as possible, with just enough slack to permit tight turns. If for any reason you should find it necessary to replace a safety cable, do not substitute with any part other than a genuine MasterCraft part.

Failure to properly attach the safety cables between your trailer and the tow vehicle can result in a run-away trailer if the trailer coupler becomes detached from the hitch.

- ✓ Upon each use of the winch, check for the proper ratchet operation. Do not use the winch if it is damaged. Seek immediate repairs.
- ✓ Maintain a firm grip on the winch handle at all times. Never release the handle when the ratchet lever is in the unlocked position with a load on the winch. The hand will spin violently under these conditions, which could cause personal injury.
- ✓ Never use the winch handle as a handle for pulling or maneuvering the entire trailer or other equipment. Never pull on the winch handle against a locked ratchet.
- ✓ Never exceed the rated capacity of the winch. Excessive loads may cause premature failure and result in serious personal injury.
- ✓ Never apply a load on the winch with the strap fully extended. Keep at least two full turns of strap on the reel.



**WARNING**

## *Safety Cables*



**WARNING**

## *Trailer Winch Assembly*

- ✓ Secure properly. When the winching operation is completed, do not depend on the winch to support the load.
- ✓ Inspect the condition of the winch strap. Using one that is damaged or worn can result in serious personal injury or damage to the boat.
- ✓ It is not recommended to use the winch as the sole method for loading the boat onto the trailer. However, it is satisfactory in assisting in the event of engine power loss.
- ✓ Check the winch straps frequently. The strength in these can deteriorate from exposure to weather, ozone and ultraviolet light. If a strap becomes frayed or worn, replace it immediately with a new one.
- ✓ A heavy grease should be applied to the gears to provide a free-running drive and to minimize the effort you have to expend to crank the boat on the trailer.

### Hinged Tongue Warning

**A**TTENTION SHOULD BE PAID TO THE FOLLOWING WARNING LABEL:

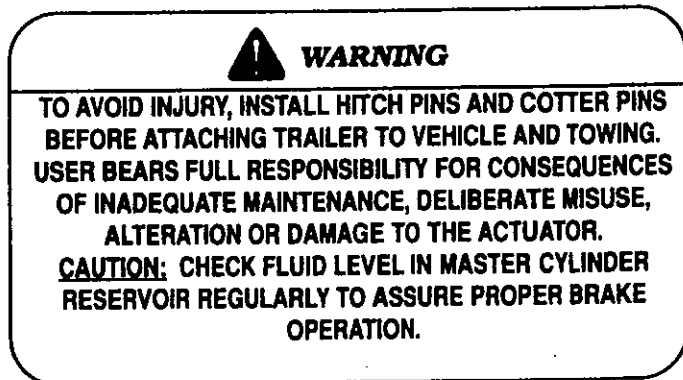

### Trailer Coupling



**Y**OUR TRAILER COUPLING IS DESIGNED TO HAVE THE REQUIRED STRENGTH WHEN A hitch ball is in its socket. It is therefore necessary to exercise care when the trailer is disconnected from the hitch that the coupling is not subjected to any impact.

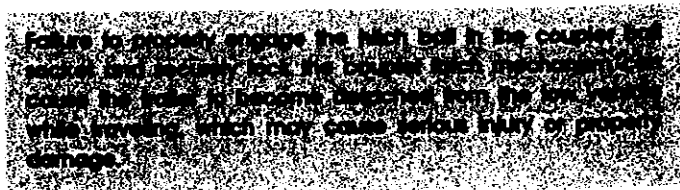

The coupling should not be allowed to lay on the ground where dirt and sand can enter the socket. This can cause excessive wear when the trailer is towed again, or it can cause the locking mechanism to jam.

If the coupler becomes damaged, it must be repaired or replaced before towing. When the coupling is placed on the ball, the latch should close firmly. Keep the latch mechanism lightly oiled and clean. Install a lock pin in the brae coupler for safety. Your MasterCraft dealer also has locking pins available for security.



## Lights

**A** SPECIAL WIRING HARNESS FOR CONNECTING THE TRAILER LIGHTS TO THE LIGHTING system of the tow vehicle comes with your trailer. Be sure the white ground wire from the connector is attached to the frame so that the hitch ball does not have to act as an electrical connection. Always have your light plug hooked up when backing your trailer. Disk brakes will not release without the special connector wired to your back-up lights on your car.

**NOTE: Some late-model cars have yellow turn signals and separate (red) stop lights. In this case, a special wiring adapter will have to be installed on the automobile.**

Here are a few things you can do to keep your trailer lighting system in good working order:

- ☛ Be sure the white ground wire is properly connected to the trailer frame. Replace any parts that are damaged or badly worn.
- ☛ A small amount of waterproof grease on the plug contacts and light bulb bases will help to prevent rust and corrosion.
- ☛ Before every trip, check for burned-out or broken bulbs, cracked or broken light lenses, etc.
- ☛ Be sure to unplug the lights each time before backing into the water. Extra plugs are available from your MasterCraft dealer.

**To reduce the risk of serious injury or property damage, make certain that all the trailer lights are in proper working order.**



**B**ECAUSE THEY ARE OFTEN EXPOSED TO WATER, TRAILER WHEELS AND TIRES require more attention than the wheels on your family car. The three major items to check are lug nuts, lubrication and the tire pressure.

## Wheels and Hubs

**Monitor the proper torque on the lug nuts or wheel bolts. Failure to do so may result in serious injury or property damage.**

**Also, keep the wheel bearings lubricated. Failure to do so may cause bearing failure and possible wheel loss, resulting in serious injury or property damage.**





## **Lug Nuts/ Wheel Bolts**

**L**OOSE LUG NUTS CAN CAUSE MORE THAN JUST AN ANNOYING WHEEL WOBBLE— you could lose a wheel. Before each trip, check for loose or missing lug nuts.

When tightening the lug nuts, use the correct-sized wrench. The wrong size can round-off the lug nuts and render them useless. If you lose a lug nut, replace it promptly. The correct size is 13/16-inch. Take special care to insure the replacement lug nut is the correct type. While the threads of the lug nut may match, it may be a size that does not hold the wheel securely against the hub, even when fully tightened. Be certain a replacement lug nut is an exact match for the original.

## **Lubrication**

**Y**OUR MasterCraft TRAILER IS EQUIPPED WITH EASY LUBRICATING HUBS. However, water invades and seeps through the smallest opening. When a warm hub is submerged in cold water, any air inside the hub will contract and draw water through the best of seals.

Trailers equipped with the Bearing Buddy II with Auto Check simplify the process of keeping watch for proper lubrication. If the blue ring is fully extended (about 1/4-inch extruded), you have adequate lubrication. As the grease dissipates, the ring will move back into the shell. When the blue ring is flush with the Bearing Buddy shell, it is time to re-lubricate.

Your best protection against wheel bearing damage from water is to always keep your wheel assembly properly lubricated. If the wheels have been in the water, the bearings should be re-packed if the trailer remains unused for two weeks or longer. When on a trip, make it a habit to check the wheel hubs every time you stop for gas or refreshments. If the hub feels abnormally hot, the bearings should be inspected before continuing your trip.

## **Wheel Bearings and Braking System**

**W**HEEL BEARINGS AND THE BRAKING SYSTEM ON THE TRAILER SHOULD BE inspected annually. If the bearings or race show signs of scoring, they should be replaced, as well as worn brake parts. Your MasterCraft dealer should perform this inspection and repair.

## **Tires**

**T**HE MOST COMMON CAUSE OF TRAILER TIRE TROUBLE IS UNDER-INFLATION. It is important, therefore, that you always maintain correct air pressure, as indicated by the tire manufacturer on the tire's sidewalls. Always check the air pressure when the tires are cold. Tires heat up and the air pressure increases after traveling only short distances. Inflate tires to the proper air pressure as noted on the sidewall of the tires.

When your trailer tires become worn or damaged, replace them with new tires. Your MasterCraft dealer can help you.

For safety and convenience, it is recommended that you always carry a spare wheel and tire.



**WARNING**

**I**N MOST STATES, TRAILERS WITH A GROSS VEHICLE WEIGHT RATING (GVWR) OF 1,500 pounds or more are required by law to have brakes on all wheels. (Auto manufacturers generally recommend brakes with even lighter trailers.)

### **Brakes**

Your MasterCraft trailer brakes are designed to operate automatically when the tow vehicle's brakes are applied. These are known as *surge brakes*. When the tow vehicle slows down or stops, the forward momentum (surge) of the trailer against the hitch ball applies pressure to a master cylinder in the trailer coupler. This pressure activates the trailer brakes through a hydraulic system, much like the brakes on your automobile.

Your surge brakes do not have an automatic brake lining adjustment system. They should be adjusted regularly to compensate for wear, depending on how often you use your trailer. Trailer brake adjustment must be checked regularly to prevent braking failure.

Try out your brakes before each trip. On a regular basis, have your brake linings inspected, necessary adjustments made and any damaged or worn parts replaced.

Wet brakes usually do not hold very well. If your wheels have been in water, several brake applications at slow speeds will dry them out.



**WARNING**

**M**asterCraft RECOMMENDS USING THE JACK TO LIFT THE COUPLING OF A LOADED trailer from the hitch ball and for moving the trailer about when it is disconnected from the towing vehicle. The trailer jack should be lowered to a minimum position and tilted horizontally before moving the trailer.

### **Trailer Jack**

Like any mechanical assembly, a jack requires maintenance to function properly over a long period of time. The drive gear and the rack and pinion should be greased. The caster and wheel bearing should be oiled frequently.

## Tie-Downs

**E**NSURING THAT YOUR MasterCraft IS HELD SECURELY IN PLACE ON THE trailer's hull support, especially when underway, is extremely important. If it is not firmly and properly secured, your boat can be damaged as it bounces against the hull supports. All the necessary tie-down hooks for holding your MasterCraft are provided on your trailer.

MasterCraft's *Boat Buddy System* is located on the winch stand. Ask your MasterCraft dealer to demonstrate the proper use of the Boat Buddy System. A separate winch strap is provided and should then be attached to hold the boat down to the trailer. Besides keeping your boat from sliding off the rear if the Boat Buddy latch would fail, it will keep the boat on the trailer during quick stops or minor collisions.



As noted previously, it is very important to be sure that the transom of your MasterCraft is resting fully and securely on the supports provided at the rear end of the trailer, and that it remains in place when parked or underway.

Check by rocking the boat on the trailer. If it does not remain firmly in place on the supports, tie-downs should be tightened or re-rigged.

## Hitching Up

**B**EFORE TRAILERING, AVOID ACCIDENTS.

- Hitch only to the ball-size marked on the coupling.
- Be certain the ball clamp captures the ball and lever or the handwell is fully closed or tightened. Insert safety pin or optional lock pin.
- Cross the safety cables under the coupling.
- Allow only enough slack in the safety cables to handle turns.

When hitching your trailer, you should always observe each item of the "Trailer Check List" on page 80. Hitching your trailer to your tow vehicle can be a one-man job, but it is easier if you have a second person to help you. Here are the basic steps:

- ☛ Back your tow vehicle as close as possible to the trailer. It's easier—and safer—than pulling the trailer to your car or truck.
- ☛ Check to be sure the coupler-locking device is released.
- ☛ Raise the front end of the trailer with your jack, position the coupler directly over the hitch ball and lower until it is all the way down over the ball.
- ☛ Check under the coupling to be certain that the ball clamp is **BELOW THE BALL** and not riding on top of the ball.
- ☛ Lock the coupler to the hitch ball. To be sure it is in the locked position and securely in place, raise up on the trailer tongue. If it comes loose from the ball, unlock and go back to the third step above.
- ☛ Be certain the jack is in the fully raised and locked position.
- ☛ Your MasterCraft trailer has a surge brake break-away cable. Attach it to the tow vehicle, making sure there is enough slack for tight turns.
- ☛ Attach the safety cables. (See page 83.)
- ☛ Connect the trailer wiring harness to the lighting system of the tow vehicle. Check the operation. (See page 85.)

**W**ITH A BOAT TRAILER IN TOW, YOU ARE OPERATING A VEHICLE COMBINATION that is longer, heavier and sometimes wider and taller than your car or truck. This means you will have to make a few adjustments in your normal driving practices to compensate for the difference. Here are a few tips to help you enjoy trailering:

- *Take a shakedown cruise.* Before you make your first major trip or first trip to the lake with your trailer, make at least one short trial run to familiarize yourself with its handling characteristics. Be sure everything is working properly.

## **Trailering Technique**

- **Slow down.** There is less strain on your car, trailer and boat at moderate to slow speeds. Also, many states have lower speed limits for vehicles towing trailers.
- **Allow extra time and space.** You'll need more of both when passing and stopping.
- **Check the rear view mirrors.** Install outside rear view mirrors on both sides of the tow vehicle. Make it a habit to check the mirrors at frequent intervals to be sure your trailer and boat are riding properly.
- **Swing wider.** Trailer wheels are closer to the inside of turns than the wheels on your car or truck. This means you should swing wider at curves and corners.
- **Pass with extra care.** With a trailer in tow, you'll need more time and distance to accelerate, get around a slower vehicle and return to the right lane.
- **Watch the wind.** Be prepared for sudden changes in air pressure and/or wind buffeting when larger vehicles pass you from either direction. Slow down a little and keep a firm hold on the steering wheel.
- **Conserve fuel.** Wind resistance against the boat and trailer can reduce your gas mileage significantly, especially at higher speeds.
- **Avoid sudden stops and starts.** Even though your trailer has brakes, a sudden stop could cause it to skid, slide or even jackknife. (Be especially careful to avoid the necessity for quick stops while turning.) Smooth, gradual starts and stops will improve your gas mileage and put less strain on your tie-downs, etc.)
- **Signal your intentions.** Well before you stop, turn, change lanes or pass, use your light signals to let other vehicles know what you intend to do.
- **Shift to a lower gear.** If your tow vehicle has a manual transmission, traveling in lower gears when going up steep hills or over sand, gravel or dirt roads will ease the load on your engine and transmission. If your tow vehicle has an overdrive gear (manual or automatic) you may get better gas mileage in a lower gear. Check the automobile owner's manual for their recommended towing specifications.
- **Always be courteous.** Make it as easy as possible for faster-moving vehicles to pass you. Remain in the slower lane and be prepared to slow down if they need extra time to return to their proper lane.

- *Don't tailgate.* Allow at least one combined-car-and-trailer-length between you and the car ahead for every 10 MPH you are traveling.

If a problem occurs, the general rule is to stay calm. Don't panic and don't do anything any more suddenly or violently than you have to.

A sudden bumping or fish-tailing may be a flat tire. Don't jam on the brakes or mash the accelerator to try to drive out of it. Stop slowly and in as straight a line as possible. If conditions permit, allow your rig to coast to a very slow speed and try to avoid braking, except when your wheels are straight ahead and the trailer and your tow vehicle are in line.

If your trailer begins to fish-tail as you accelerate to highway speed, back off a little and it should cease. If it begins again as you accelerate, stop and check your load. If it is not evenly distributed side-to-side, or it is too far back so that the hitch load becomes too low, the result can be this condition. Re-distribute the load before continuing.

**E**VERY MasterCraft OWNER DEVELOPS THEIR OWN FAVORITE LAUNCHING TECHNIQUE. Until you do, here are a few helpful tips:

- ✓ Check the ramp first. Whether you're launching from an unimproved or surfaced ramp, check it out before starting your launching procedure. How steep is it? Is the surface firm enough to support the weight of the trailer rig and tow vehicle? Is it wide enough? How deep is the water at the end of the ramp?

Some sloped ramps become very slippery when wet.

- ✓ Prepare for launching. Install your drain plugs and detach the trailer tie-downs.
- ✓ Back your trailer down to the ramp. If possible, have someone stand to one side of the ramp to direct you. Backing up a trailer can be tricky. A good way to simplify the procedure is to grasp the steering wheel with one hand at its lowest point (6 o'clock). When you want the trailer to go right, move your hand on the wheel to the right; to make the trailer go left, move your hand to the left.

## Launching



- ✓ Back your trailer into the water until the trailer tire wheel well is about two inches from the top of the water surface. Set the parking brake and shift into park (automatic transmission) or first gear (manual transmission). Shut off the the engine. Unlock the Boat Buddy latch and winch hook; then back the boat off the trailer.

To re-load the boat on the trailer, simply reverse the above procedure, including setting your Boat Buddy latch to the proper position, and drive your on the trailer at a slow pace. Before loading, we recommend you clean any dirt or sand off the rollers and bunks. Sand on these can abrade the boat's bottom while trailering.

Be certain all the boat tie-downs are properly fastened before departing from the launching ramp area.



## Storage

**W**HEN YOUR MasterCraft TRAILER WILL NOT BE IN USE FOR SEVERAL MONTHS, you can help it continue to give you good performance by taking the following steps:

- If at all possible, park your boat-trailer rig in a protected area such as a garage, carport or similar shelter.
- If you must park the trailer outdoors, install a boat cover that is tight enough for adequate protection but not air-tight.
- Service or re-pack the wheel bearings.
- Jack up the trailer and place blocks under the trailer frame to take most of the weight off the trailer springs and tires.
- Loosen the tie-downs and winch strap, but be sure the boat is still resting properly on the hull supports.
- Remove the drain plug and elevate the trailer tongue slightly (just an inch or two) to allow water to drain out so the boat will be dry. Tie the plug to something obvious—like the steering wheel—so you will remember to replace the drain plug before your next trip!
- A good time to touch up rust spots, nicks and chips is when the trailer is in storage. Replace damaged tie-downs, winch straps, wiring, etc.

- Lubricate moving parts such as the rollers and winch, as well as the ball coupler.
- Tighten any loose nuts and bolts.
- ☞ The jack and lug wrench that came with your tow vehicle may also work on your trailer, but don't count on it! Check to make sure.
- ☞ Your trailer will look better and last longer if you rinse it off with fresh water several times a year. If you boat in brackish or salt water, the trailer should be rinsed thoroughly after every trip. An annual washing with a mild detergent and waxing with an auto wax also will help to keep your trailer bright and clean.
- ☞ Make up a special Boating Kit and carry it with you on all trips. The kit should including a spare wheel and tire, lug wrench, wheel chocks, bearing grease, spare strap (for tie-downs and winch) extra lights, wheel bearings and road flares.
- ☞ Some insurance policies do not provide coverage when towing a trailer. Check your policy, or call your insurance agent to be sure you are fully covered.

## ***Trailering Tips***



# Index

<b>A</b>	
Accessory Switch .....	22
Anchor Lights .....	21
Automatic Bilge Pump Switch .....	22
<b>B</b>	
Basic Maneuvering .....	35
Battery Connections/Hold-downs, Inspect ...	49
Before Starting .....	30
Belts, Check .....	47
Blower Switch .....	21
Boat Break-In, New .....	27
<b>C</b>	
Certification .....	4
Check Engine Light .....	20
Circuit Breakers .....	22
Cleaning .....	41
Construction Standards .....	3
Controls and Indicators .....	18
Cooling System, Check .....	46
Corrosion .....	40
<b>D</b>	
Docking and Tie-Up .....	37
<b>E</b>	
Engine Flame Arrestor, Clean .....	53
Engine Mounts, Check .....	56
Engine Oil Change .....	51
Engine Oil Check .....	46
Engine Oil Pressure Gauge .....	20
Engine Temperature Gauge .....	19
Exhaust Flaps, Inspect .....	56
Exhaust System Leaks, Inspect for .....	50
<b>F</b>	
First Time Operation .....	35
Fuel Filter, Check/Service .....	47
Fuel Gauge .....	19
Fuel System, Inspect .....	56
Fuel System Leaks, Inspect for .....	51
Fueling .....	24
<b>G</b>	
General Precautions .....	7
<b>H</b>	
Hardware, Check .....	48
Horn Switch .....	21
High-Speed Operation .....	36
<b>I</b>	
Ignition Switch .....	21
Instrument & Navigational Lights .....	21
<b>L</b>	
Lifting the Boat .....	38
Lights, Replacing .....	61
<b>M</b>	
Manual Bilge Pump Switch .....	22
<b>O</b>	
Operation, Break-In .....	28
Operational Hints .....	34
Optional Equipment .....	72
<b>P</b>	
Propeller, Change .....	58
Propeller, Check/Repair .....	59
Propeller Shaft Coupling Alignment .....	54
Propeller Shaft, Inspect .....	50
<b>R</b>	
Recommended Equipment .....	8
Required Equipment .....	8
<b>S</b>	
Safety .....	6
Safety Afloat .....	9

Safety Checks and Services .....	26	Wheels & Hubs .....	85
Safety Equipment .....	7	Winch Assembly .....	83
Safety Switch .....	21	Transmission Fluid, Change .....	53
Scheduled Maintenance Checks & Services ..	44	Transmission Fluid Check .....	46
Before Each Use .....	46	Troubleshooting .....	66
Quarterly (Every 50 Hours) .....	51	Tune-up, Engine .....	53
Annually (Every 100 Hours) .....	53		
Serial Number Locations .....	4		
Service Log .....	94	Unscheduled Maintenance .....	58
Shift/Throttle Cables, Inspect .....	48	Unusual Operating Conditions .....	36
Shift/Throttle Cables, Lubricate .....	55		
Shift/Throttle Control .....	23		
Shifting Gears .....	32	Voltmeter .....	19
Specifications .....	70		
Speedometer .....	18		
Speedometer Calibration .....	60	Warranty, Dealer Service and .....	74
Standard Features .....	3	Warranty, MasterCraft Limited .....	77
Starter Gear & Shaft, Lubricate .....	52	Warranty Registration .....	98
Starting and Basic Operation .....	30	Winterization .....	62
Starting the Engine .....	31		
Steering System, Lubricate .....	54		
Steering Wheel .....	23		
Stopping .....	33		
Storage Cradle .....	39		
Storage/Winterization .....	62		
Tachometer/Engine Hourmeter .....	18		
Trailers .....	79		
Brakes .....	87		
Check List .....	80		
Coupling .....	84		
Hitch .....	82		
Hitching Up .....	88		
Launching .....	91		
Lights .....	85		
Load-Carrying Capacity .....	81		
Lubrication .....	86		
Lug Nuts/Wheel Bolts .....	86		
Match .....	81		
Safety Cables .....	83		
Storage .....	92		
Tie-downs .....	88		
Tips .....	93		
Tires .....	86		
Trailer Jack .....	87		
Trailer Techniques .....	89		
Weight Distribution .....	81		

Enjoy  
**EY**  
our

***MasterCraft***

# Service Log

Every 50 Hours	Date	Date	Date	Date
Engine oil & filter change				
Engine starter gear and shaft lubrication				
Safety equipment check				
Replace fuel filters				
Every 100 Hours	Date	Date	Date	Date
Engine oil & filter change				
Clean engine flame arrestor				
Replace fuel filters				
Clean fuel tank pick-up				
Engine tune-up				
Change transmission fluid				
Clean battery terminals				
Check propeller shaft coupling alignment				
Lubricate steering system				
Lubricate shift and throttle cables				
Inspect exhaust flaps for damage*				
Check engine mounts				
Inspect complete fuel system for leakage				

\*Best accomplished with the boat out of the water.

# Service Log

Every 50 Hours	Date	Date	Date	Date
Engine oil & filter change				
Engine starter gear and shaft lubrication				
Safety equipment check				
Replace fuel filters				
<b>Every 100 Hours</b>	<b>Date</b>	<b>Date</b>	<b>Date</b>	<b>Date</b>
Engine oil & filter change				
Clean engine flame arrestor				
Replace fuel filters				
Clean fuel tank pick-up				
Engine tune-up				
Change transmission fluid				
Clean battery terminals				
Check propeller shaft coupling alignment				
Lubricate steering system				
Lubricate shift and throttle cables				
Inspect exhaust flaps for damage*				
Check engine mounts				
Inspect complete fuel system for leakage				

\*Best accomplished with the boat out of the water.